

Capacitor Switching Contactors



D385E51

Technical catalogues and news under: www.benedict.at

**Contactors
Motor-Starter**



Mini-Contactors
Contactors
Overload Relays
Capacitor Switching
Contactors
Motor-Starters
Modular Contactors

 Catalogue **D677E..**

**Circuit
Breakers**



M4-32T... up to 32A
M4-32R.. up to 32A
M4-63R... up to 63A
M4-100R... up to 100A

 Catalogue **D795E..**

Switches



On- Off Switches
Changeover Switches
Motor Switches
Step Switches
Main Switches
Modular Switches
Key Operated Switches

 Catalogue **D371E..**

**Main
Switches**



Emergency Off
Main Switches
On-Off-Switches
Add-On-Module

 Catalogue **D656E..**

**Capacitor Switching
Contactors**



Contactors
for reactive
and non reactive
capacitor banks

 Catalogue **D385E..**

**Manual
Motorstarter**



MU25A up to 25A
Auxiliary Contact Blocks
Trip Alarm Auxiliary Switches
Busbar Connectors
Enclosure

 Catalogue **D509E..**

Push Buttons



Push Buttons
Emergency Stop
Key Operated Rotary Switches
Rotary Knobs
Illuminated Push Buttons
Assembled Stations

 Catalogue **D580E..**

**Modular-
Contactors**



Modular Contactors
Accessories
Emergency Off Switches
Main Switches
On-Off Switches
Control Switches

 Catalogue **D681E..**

**Low Voltage-
Control Gear**



Contactors
D.O.L. Starters
Overload Relays
Manual Motor Starters
Main Switches
Circuit Breakers
Cam Switches
Push Buttons

 Catalogue **D651E..**

**DC-Switchgear
for Photovoltaic**



Main Switches
On-Off-Switches
Contactors for
DC-Switching

 Catalogue **D911E..**



Capacitor Switching -Contactors

2



Contactors

3



Auxiliary Contact Blocks

3



Technical Data

4, 5, 6

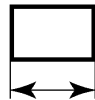

Dimensions

7

Typical Circuit Diagram

8

Contactor operation

8

Function

9,10,11

Capacitor Switching Contactors

for use with reactive or non-reactive capacitor banks

Rated Operational Power at 50/60Hz						Aux. Contacts		Type	Coil voltage ¹⁾ 220-240V 50Hz	Pack pcs.	Weight kg/pc.
Ambient Temperature						Built-in Add.					
50°C			60°C			NO	NC	230	↓		
380V	415V	660V	380V	415V	660V	1	1				
400V	440V	690V	400V	440V	690V	1	1				
kVA _r	kVA _r	kVA _r	kVA _r	kVA _r	kVA _r						
0-12,5	0-13	0-20	0-12,5	0-13	0-20	1	-	1 ²⁾	K3-18NK10 ...	1	0,34
0-12,5	0-13	0-20	0-12,5	0-13	0-20	-	1	1 ²⁾	K3-18NK01 ...	1	0,34
10-20	10,5-22	17-33	10-20	10,5-22	17-33	-	-	3 ³⁾	K3-24K00 ...	1	0,62
10-25	10,5-27	17-41	10-25	10,5-27	17-41	-	-	3 ³⁾	K3-32K00 ...	1	0,62
20-33,3	23-36	36-55	20-33,3	23-36	36-55	-	-	3 ³⁾	K3-50K00 ...	1	1,0
20-50	23-53	36-82	20-50	23-53	36-82	-	-	3 ³⁾	K3-62K00 ...	1	1,0
20-75 ⁴⁾	23-75 ⁴⁾	36-120 ⁴⁾	20-60	23-64	36-100	-	-	3 ³⁾	K3-74K00 ...	1	1,0
33-80	36-82	57-120	33-75	36-77	57-120	-	-	6 ⁵⁾	K3-90K00 ... / VS ⁷⁾	1	2,3
33-100 ⁶⁾	36-103 ⁶⁾	57-148 ⁶⁾	33-90 ⁶⁾	36-93 ⁶⁾	57-148 ⁶⁾	-	-	6 ⁵⁾	K3-115K00 ... / VS ⁷⁾	1	2,3



Specification: Contactors K3...K are suitable for switching low-inductive and low loss capacitors in capacitor banks (IEC70 and 831, VDE 0560) without and with reactors.

Capacitor switching contactors are fitted with early make contacts and damping resistors, to reduce the value of make current <math>< 70 \times I_g</math>.

Operating Conditions: Capacitor switching contactors are protected against contact welding for a prospective making current of $200 \times I_g$.

Mounting instructions:

In the area of capacitor switching contactors, difficulty inflammable and self-extinguishing materials shall be used only, because abnormal temperatures within the area of the resistor spirals cannot be excluded.

Technical Data acc. to IEC 947-4-1, IEC 947-5-1, EN 60947-4-1, EN 60947-5-1, VDE 0660

Type		K3-18NK	K3-24K	K3-32K	K3-50K	K3-62K	K3-74K	K3-90K	K3-115K
Max. frequency of operations z	1/h	120	120	120	120	120	80	80	80
Contact life	non reactive capacitor banks S x 10 ³	250	150	150	150	150	120	120	120
	reactive capacitor banks S x 10 ³	400	300	300	300	300	200	200	200
Rated operational current I _g AC6b	at 50°C A	0-18	14-28	14-36	30-48	30-72	30-108	50-115	50-144
	at 60°C A	0-18	14-28	14-36	30-48	30-72	30-87	50-108	50-130
Rated operational current I _{th} AC1	at 50°C A	32	45	60	100	110	120	155	190
	at 60°C A	32	40	55	90	100	110	145	170
Overload factor acc. to EN 61921: 30% min.	at 50°C %	78	60	67	108	53	11	35	32
	at 60°C %	78	43	53	88	39	26	34	31
Fuses gL (gG)	from / to A	35 / 63	50 / 80	63 / 100	80 / 160	125 / 160	160/200	160/200	160/250

1) Coil voltage range and non-standard coil voltages see page 3

2) 1 HN.. or HA.. snap-on

3) 2HB.. for side mounting and 1 HN.. or HA.. snap-on

4) Consider the max. thermal current of the contactor K3-74A: I_{th} 130A

5) 2 HB.. on the left or right side and 4 HN.. or HA.. snap-on

6) Consider the min. cross-section of conductor at max. load

7) Type 230 for AC- and DC-operating 220-240V 50/60Hz and 220V DC (with integrated coil suppressor)

Type 230VS for AC-operating 220-240V 50Hz (with integrated coil suppressor)

Contactors

for use with reactive capacitor banks

Rated Operational Power at 50/60Hz Ambient Temperature	50°C						60°C			Aux. Contacts		Type	Coil Voltage 220-240V 50Hz	Pack pcs.	Weight kg/pc.
	380V	415V	660V	380V	415V	660V	NO	NC	pcs.	230 ↓					
	kVA _r	kVA _r	kVA _r	kVA _r	kVA _r	kVA _r									
5	5,5	8	5	5,5	8	1	-	4 ¹⁾			K3-10ND10 ...	1	0,23		
9	9,5	15	9	9,5	15	1	-	4 ¹⁾			K3-14ND10 ...	1	0,23		
12,5	13	20	12,5	13	20	1	-	4 ¹⁾			K3-18ND10 ...	1	0,23		
13	14	22	13	14	22	1	-	4 ¹⁾			K3-22ND10 ...	1	0,23		
20	22	33	20	22	33	-	-	6 ²⁾			K3-24A00 ...	1	0,48		
25	27	41	25	27	41	-	-	6 ²⁾			K3-32A00 ...	1	0,48		
27,5	30	48	27,5	30	48	-	-	6 ²⁾			K3-40A00 ...	1	0,48		
33,3	36	55	33,3	36	55	-	-	6 ²⁾			K3-50A00 ...	1	0,85		
50	53	82	50	53	82	-	-	6 ²⁾			K3-62A00 ...	1	0,85		
75³⁾	75 ³⁾	100	60	64	100	-	-	6 ²⁾			K3-74A00 ...	1	0,85		
80	82	120	75	77	120	-	-	9 ⁴⁾			K3-90A00 ... / VS ⁷⁾	1	2,2		
100⁵⁾	103 ⁵⁾	148 ⁵⁾	90 ⁵⁾	93 ⁵⁾	148 ⁵⁾	-	-	9 ⁴⁾			K3-115A00 ... / VS ⁷⁾	1	2,2		

Auxiliary Contact Blocks

Rated Operational Current AC15 230V A	Operational Current			For Contactors	Contacts		Type	Pack pcs.	Weight kg/pc.
	400V A	AC1 690V A			NO	NC			
6	4	25		K3-10.. to K3-115..	-	1	HA01	10	0,03
3	2	10		K3-24.. to K3-115..	1	1	HB11	10	0,02
3	2	10		for side mounting	-	2	HB02	10	0,02
3	2	10		K3-10.. to K3-115..	1	-	HN10	10	0,02
3	2	10		K3-10.. to K3-115..	-	1	HN01	10	0,02

Coil Voltages and Voltage Ranges for capacitor switching contactors

Suffix to contactor type e.g. K3-18NK10 24	for contactor-Type K3-10.. to K3-74..						Suffix to contactor type z.B.: K3-90K00 230	for contactor-Type K3-90.. to K3-115..					
	Voltage Marking		Rated Control Voltage U _s					Voltage Marking		Rated Control Voltage U _s			
	at the coil for 50Hz	for 60Hz	range for 50Hz		for 60Hz			at the coil for 50/60Hz	for DC	range for 50Hz		for 60Hz	
	V	V	min.	max.	min.	max.	V	V	V	V	V	V	
24	24	24	22	24	24	27	24	24	24	22	24	22	24
48	48	48	44	48	48	52	48	48	48	44	48	44	48
110	110	110-120	100	110	110	122	110	110-120	110	110	120	110	120
180	180-210	200-240	180	210	200	240	200	200-220	200	200	220	200	220
230	220-240	230-264	220	240	230	264	230	220-240	220	220	240	220	240
400	380-415	400-440	380	415	400	460	400	380-415	-	380	415	380	415

- 1) 4 HN.. or HA.. snap-on
- 2) 2 HB.. on the left or right side and 4 HN.. or HA.. snap-on
- 3) Consider the max. thermal current: I_{th} 130A
- 4) 2 HB.. on the left or right side and 7 HN.. or HA.. snap-on
- 5) Consider the min. cross-section of conductor at max. load
- 7) Type 230 for AC- and DC-operating 220-240V 50/60Hz and 220V DC (with integrated coil suppressor)
Type 230VS for AC-operating 220-240V 50Hz (with integrated coil suppressor)

Capacitor Switching Contactors

Data according to IEC 947-4-1, EN 60947-4-1, VDE 0660

Main Contacts	Type	K3-18NK	K3-24K	K3-32K	K3-50K	K3-62K	K3-74K	K3-90K	K3-115K
Utilization category AC6b									
Switching of non-reactive and reactive 3-phase capacitor banks									
Ambient temperature $\leq 50^{\circ}\text{C}$									
Rated operational current I_e	690V A	0-18	14-28	14-36	30-48	30-72	30-108 ¹⁾	50-115	50-144 ²⁾
Rated operational power	220-240V kVAr	0-7	5-11	5-14	12-20	12-28	12-33	20-45	20-55 ²⁾
	380-400V kVAr	0-12,5	10-20	10-25	20-33,3	20-50	20-75 ¹⁾	33-80	33-100 ²⁾
	415-440V kVAr	0-13	10,5-22	10,5-27	23-36	23-53	23-75 ¹⁾	36-82	36-103 ²⁾
	500V kVAr	0-15	12-25	12-30	26-40	26-60	26-75	43-100	43-120 ²⁾
	525V kVAr	0-15	12-25	12-32	26-43	26-64	26-80	45-105	45-125 ²⁾
	660-690V kVAr	0-20	17-33	17-41	36-55	36-82	36-120	57-120	57-148 ²⁾
	750V kVAr	-	-	-	-	-	-	65-130	65-165 ²⁾
	1000V kVAr	-	-	-	-	-	-	85-150	85-180 ²⁾
Ambient temperature $\leq 60^{\circ}\text{C}$									
Rated operational current I_e	690V A	0-18	14-28	14-36	30-48	30-72	30-87	50-108	50-130 ²⁾
Rated operational power	220-240V kVAr	0-7	5-11	5-14	12-20	12-28	12-30	20-40	20-50 ²⁾
	380-400V kVAr	0-12,5	10-20	10-25	20-33,3	20-50	20-60	33-75	33-90 ²⁾
	415-440V kVAr	0-13	10,5-22	10,5-27	23-36	23-53	23-64	36-77	36-93 ²⁾
	500V kVAr	0-15	12-25	12-30	26-40	26-60	26-70	43-90	43-110 ²⁾
	525V kVAr	0-15	12-25	12-32	26-43	26-64	26-75	45-95	45-115 ²⁾
	660-690V kVAr	0-20	17-33	17-41	36-55	36-82	36-100	57-120	57-148 ²⁾
	750V kVAr	-	-	-	-	-	-	65-130	65-165 ²⁾
	1000V kVAr	-	-	-	-	-	-	85-150	85-180 ²⁾

Contactors

Data according to IEC 947-4-1, EN 60947-4-1, VDE 0660



Main Contacts	Type	K3-10	K3-14	K3-18	K3-22	K3-24	K3-32	K3-40	K3-50	K3-62	K3-74	K3-90	K3-115
Utilization category AC6b													
Switching of reactive capacitor banks													
Ambient temperature $\leq 50^{\circ}\text{C}$													
Rated operational current I_e	690V A	8	13	18	20	28	36	42	48	72	108 ¹⁾	115	144 ²⁾
Rated operational power	220-240V kVAr	2,9	5	7	7,5	11	14	16	20	28	33	45	55 ²⁾
	380-400V kVAr	5	9	12,5	13	20	25	27,5	33,3	50	75 ¹⁾	80	100 ²⁾
	415-440V kVAr	5,5	9,5	13	14	22	27	30	36	53	75 ¹⁾	82	103 ²⁾
	500V kVAr	6	11	15	17	25	30	36	40	60	75	100	125 ²⁾
	525V kVAr	6	11	15	17	25	32	36	43	64	80	105	125 ²⁾
	660-690V kVAr	8	15	20	22	33	41	48	55	82	120	120	148 ²⁾
	750V kVAr	-	-	-	-	-	-	-	-	-	-	130	165 ²⁾
	1000V kVAr	-	-	-	-	-	-	-	-	-	-	150	180 ²⁾
Ambient temperature $\leq 60^{\circ}\text{C}$													
Rated operational current I_e	690V A	8	13	18	20	28	36	42	48	72	87	108	130 ²⁾
Rated operational power	220-240V kVAr	2,9	5	7	7,5	11	14	16	20	28	30	40	50 ²⁾
	380-400V kVAr	5	9	12,5	13	20	25	27,5	33,3	50	60	75	90 ²⁾
	415-440V kVAr	5,5	9,5	13	14	22	27	30	36	53	64	77	93 ²⁾
	500V kVAr	6	11	15	17	25	30	36	40	60	70	90	110 ²⁾
	525V kVAr	6	11	15	17	25	32	36	43	64	75	95	115 ²⁾
	660-690V kVAr	8	15	20	22	33	41	48	55	82	100	120	148 ²⁾
	750V kVAr	-	-	-	-	-	-	-	-	-	-	130	165 ²⁾
	1000V kVAr	-	-	-	-	-	-	-	-	-	-	150	180 ²⁾

1) Consider the max. thermal current: I_{th} 130A

2) Consider the min. cross-section of conductor at max. load

Contactors

Data according to IEC 947-4-1, EN 60947-4-1, VDE 0660

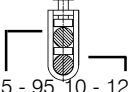
Main Contacts	Type	K3-10	K3-14	K3-18	K3-22	K3-24	K3-32	K3-40	K3-50	K3-62	K3-74	K3-90	K3-115	
Rated insulation voltage U_i ¹⁾	V AC	690	690	690	690	690	690	690	690	690	690	1000	1000	
Rated operational current I_e (= I_{th}) at 40°C, open 690V	A	25	25	32	32	50	65	80	110	120	130	160	200	
Maximum ambient temperature														
Operation	open °C	-40 to +60 (+90) ²⁾												
	enclosed °C	-40 to +40												
Storage	°C	-50 to +90												
Short circuit protection														
Coordination-type "1" acc. to IEC 947-4-1														
Contact welding without hazard of persons														
fuse size	from gL (gG) A	35	35	35	35	50	63	63	80	125	160	160	160	
	to gL (gG) A	63	63	63	63	80	100	100	160	160	200	200	250	
Cable cross-sections														
for contactors without thermal overload relay														
1 cable per clamp														
main connector	solid or stranded mm ²	0,75 - 6				1,5 - 25			4 - 50			0,5 - 95		10 - 120
	flexible mm ²	1 - 4				2,5 - 16			10 - 35			0,5 - 70		25 - 95
	flexible with multicore cable end mm ²	0,75 - 4				1,5 - 16			6 - 35			0,5 - 70		10 - 95
2 cables per clamp														
	solid or stranded mm ²	6+(1-6) / 4+(0,75-4)				16+(2,5-6) / 10+(4-10)			50+4 / 35+6 / 25+(6-16)			top 0,5-95		below 10-120
	flexible mm ²	2,5+(0,75-2,5) / 1,5+(0,75-1,5)				6+(4-6) / 4+(2,5-4)			16+(6-16) / 10+(6-16)			0,5-70		10-95
	flexible mm ²	6+(1,5-6) / 4+(1-4)				16+(2,5-6) / 10+(4-10)			50+(4-10) / 35+(4-16)			0,5-70		10-95
	flexible mm ²	2,5+(0,75-2,5) / 1,5+(0,75-1,5)				6+(4-6) / 4+(2,5-4)			25+(4-25) / 16+(4-16)			0,5-70		10-95
Cables per clamp		2												
Screw / screw driver		M3,5 / Pz2				M5 / Pz2			M6 / Pz3			1+1		M8 / 4mm-inbus
Tightening torque	Nm/lb.inch	0,8-1,4 / 7-12				2,5-3 / 22-26			3,5-4,5 / 31-40			4-6,5 / 35-57		
for main connector	solid AWG	18 - 10				16 - 10			12 - 10			-		-
	flexible AWG	18 - 10				14 - 4			10 - 0			-		-
Cables per clamp		2				1			1			-		-
	solid AWG	10+(16-10) / 12+(18-12)				10+(16-10) / 12+(18-12)			10+(12-10) / 12+12			top 18-10		below -
	flexible AWG	14+(18-14) / 16+(18-16)				14+(18-14) / 16+(18-16)			1+(12-10) / 2+(8-12)			18-3/0		8-4/0
	flexible AWG	10+(14-10) / 12+(18-12)				4+(18-12) / 6+(18-8)			3+(12-8) / 4+(10-6)			18-3/0		8-4/0
	flexible AWG	14+(18-14) / 16+(18-16)				8+(18-8) / 10+(18-12)			3+(12-8) / 4+(10-6)			18-3/0		8-4/0
Cables per clamp		2				2			2			1+1		
Mechanical life														
AC operated	S x 10 ⁶	10				10			10			5		5
DC operated	S x 10 ⁶	10				10			10			5		5
Short time current	10s-current A	96	120	144	176	184	240	296	360	504	592	680	880	
Power loss														
per pole	at I_e /AC3 400V W	0,21	0,35	0,5	0,75	0,7	1,3	2	2,2	3,9	5,5	4,3	6,0	
Auxiliary Contacts														
Rated insulation voltage U_i ¹⁾	V~	690				-			-			-		-
Thermal rated current I_{th} to 690V														
Ambient temperature	40°C A	16				-			-			-		-
	60°C A	12				-			-			-		-
Utilization category AC15	220-240V A	12				-			-			-		-
Rated operational current I_e	380-415V A	4				-			-			-		-
	440V A	4				-			-			-		-
	500V A	3				-			-			-		-
	660-690V A	1				-			-			-		-
Utilization category DC13	60V A	8				-			-			-		-
Rated operational current I_e	110V A	1				-			-			-		-
	220V A	0,1				-			-			-		-
Short circuit protection														
short-circuit current 1kA, contact welding not accepted														
max. fuse size	gL (gG) A	25				-			-			-		-

1) Suitable at 690V for: earthed-neutral systems, overvoltage category I to IV, pollution degree 3 (standard-industry): $U_{imp} = 8kV$.

Data for other conditions on request.

2) With reduced control voltage range 0,9 up to $1,0 \times U_s$ and with reduced rated current I_e /AC1 according to I_e /AC3

Data according to IEC 947-4-1, EN 60947-4-1, VDE 0660

Type	K3-10	K3-14	K3-18	K3-22	K3-24	K3-32	K3-40	K3-50	K3-62	K3-74	K3-90	K3-115
Control Circuit												
Power consumption of coils												
AC operated	inrush VA	33-45			90-115			140-165			190-280	
	sealed VA	7-10			9-13			13-18			2,5-5	
	W	2,6-3			2,7-4			5,4-7			2,5-5	
DC operated	inrush W	75			140			200			190-280	
	sealed W	2			2			6			2,5-5	
Operation range of coils												
in multiples of control voltage U_s												
	AC operated	0,85-1,1			0,85-1,1			0,85-1,1			0,85-1,1	
	DC operated	0,8-1,1			0,8-1,1			0,8-1,1			0,8-1,1	
Switching time												
at control voltage $U_s \pm 10\%$ ^{1) 2)}												
AC operated	make time ms	8-16			10-25			12-28			20-35	
	release time ms	5-13			8-15			8-15			35-50	
	arc duration ms	10-15			10-15			10-15			10-15	
DC operated	make time ms	8-12			10-20			12-23			20-35	
	release time ms	8-13			10-15			10-18			35-50	
	arc duration ms	10-15			10-15			10-15			10-15	
Cable cross-section												
Auxiliary connector	solid mm ²	0,75-6			-			-			-	
	flexible mm ²	1-4			-			-			-	
	flexible with multicore cable end mm ²	0,75-4			-			-			-	
Magnet coil	solid mm ²	0,75-2,5			0,75-2,5			0,75-2,5			0,75-2,5	
	flexible mm ²	0,5-2,5			0,5-2,5			0,5-2,5			0,5-2,5	
	flexible with multicore cable end mm ²	0,5-1,5			0,5-1,5			0,5-1,5			0,5-1,5	
Clamps per pole		2			2			2			2	
Screw / screw driver		M3,5 / Pz2			M3,5 / Pz2			M3,5 / Pz2			M3,5 / Pz2	
Tightening torque	Nm/lb.inch	0,8-1,4 / 7-12			0,8-1,4 / 7-12			0,8-1,4 / 7-12			0,8-1,4 / 7-12	
Auxiliary connector	solid AWG	18 - 10-			-			-			-	
	flexible AWG	18 - 10			-			-			-	
Magnet coil	solid AWG	14 - 12			14 - 12			14 - 12			14 - 12	
	flexible AWG	18 - 12			18 - 12			18 - 12			18 - 12	
Clamps per pole		2			2			2			2	

Capacitor Switching Contactors for North America

Data according to UL508

Main Contacts (cULus)	Type	K3-18NK	K3-24K	K3-32K	K3-50K	K3-62K	K3-74K	K3-90K	K3-115K
Rated operational power of 3-phase capacitor banks at 60Hz (3ph)	110-120V kVAr	0-3,5	3-5,5	3-7	6,5-10	6,5-15	6,5-18 ³⁾	10-24	10-28 ⁴⁾
	200V kVAr	0-6	4,5-10	4,5-12,5	10-16,7	10-25	10-32 ³⁾	17-40	17-46 ⁴⁾
	220-240V kVAr	0-7	5,5-11	5,5-15	12,5-20	12,5-30	12,5-36 ³⁾	20-47	20-56 ⁴⁾
	440-480V kVAr	0-15	11,5-25	11,5-30	25-40	25-60	25-72 ³⁾	40-95	40-114 ⁴⁾
	550-600V kVAr	0-18	14,5-30	14,5-35	31-50	31-75	31-90 ³⁾	50-120	50-143 ⁴⁾
Fuse Class RK5 / Short-circuit current	A/kA	50/5	90/5	125/5	200/5	250/5	300/5	300/10	300/10
Fuse Class T / Short-circuit current	A/kA	70/100	110/100	150/100	175/100	175/100	175/100	300/100 ⁵⁾	300/100 ⁵⁾
Rated voltage	V	600	600	600	600	600	600	600	600
Auxiliary Contacts (cULus)		A600	-	-	-	-	-	-	-

1) Total breaking time = release time + arc duration

2) Values for delay of the release time of the make contact and the make time of the break contact will be increased, if magnet coils are protected against voltage peaks (varistor, RC-unit, diode-unit)

3) Consider the max. thermal current of the contactor K3-74A: I_m 130A

4) Consider the min. cross-section of conductor at max. load

5) Class T and Class RK1

Contactors

Dimensions

Capacitor switching contactors, AC operated

K3-18NK..

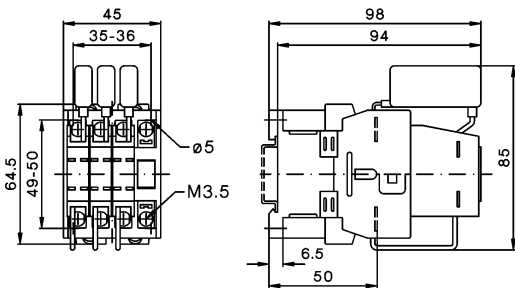

Contactors AC-operated

K3-10ND10
K3-14ND10
K3-18ND10
K3-22ND10

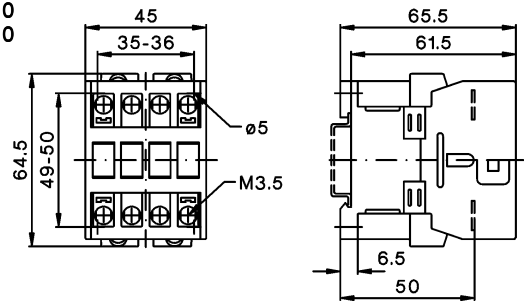

K3-24K00
K3-32K00

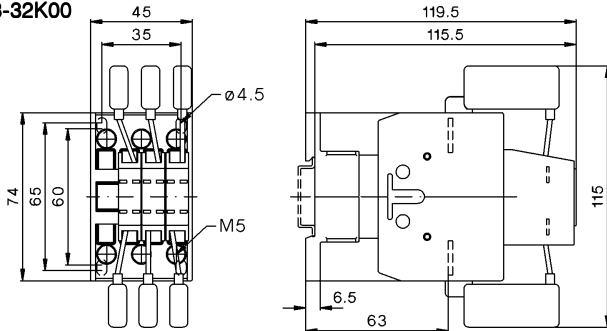

K3-24A00
K3-32A00
K3-40A00

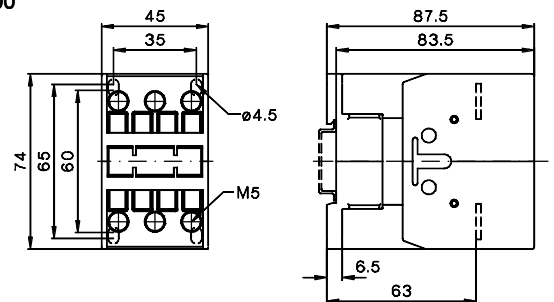

K3-50K00
K3-62K00
K3-74K00

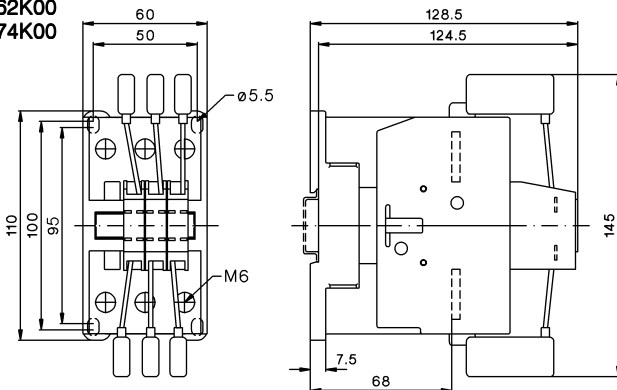

K3-50A00
K3-62A00
K3-74A00

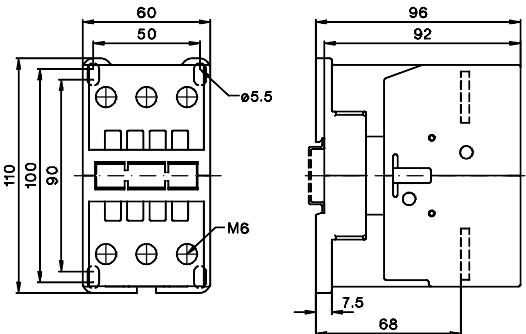

K3-90K00
K3-115K00

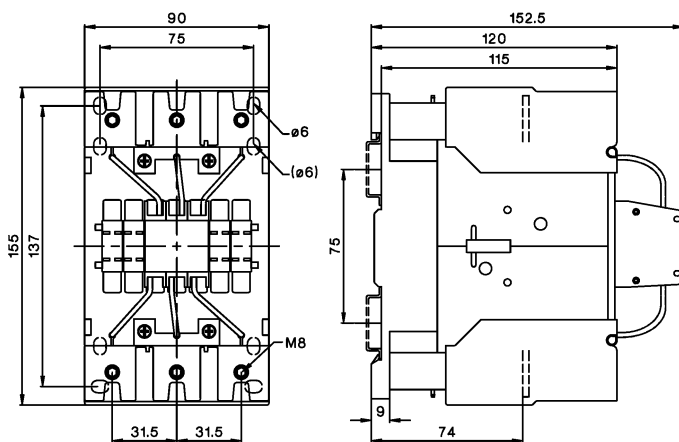

K3-90A00
K3-115A00

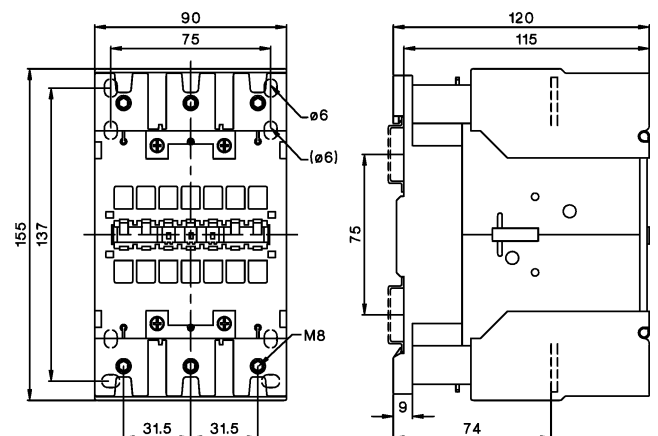

Typical Circuit Diagram of Capacitor Switching Contactors

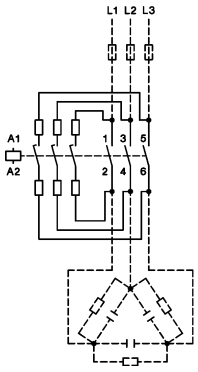

Typical Circuit Diagram

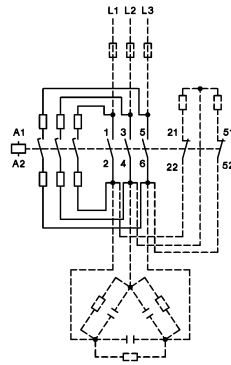

Wiring Diagram for Quick Discharge Resistors

Make sure that the current of the discharge resistors is not higher than the rated current (AC1) of the auxiliary contacts

Contactor operation at direct switching of capacitors

Theoretic view of function

Make

In case of the pre-contacts during make, the current peaks are attenuate by resistor wires. These current peaks would weld the main-contacts of contactor and they are also not good for the capacitors.

The total resistance of the resistor wires is mostly ohmic, the inductive one can be ignored. The looking like a coil is only a case of construction.

The single controlled pre-contacts are increasing the safety of operating, in opposite of contamination during operation.

Operation:

During operation the resistor wires are not getting warmer, because they are not in the circuit.

Break:

Important: these contactors can be used for both installations, because the pre-contacts have no function during break, thus means that the peaks of the break-over voltage (power) of the chokes can't make any damage.

Description

Function diagram

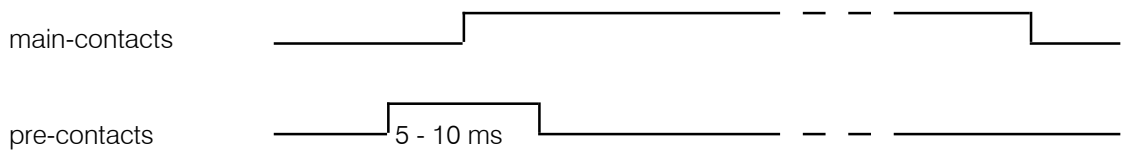

Practical function - oscillogram

make with pre-contacts (B&J\Oszi11)

K3-18NK 12.5kVAr (18A / 400V)

vertical: **250A** / div horizontal: 1ms / div

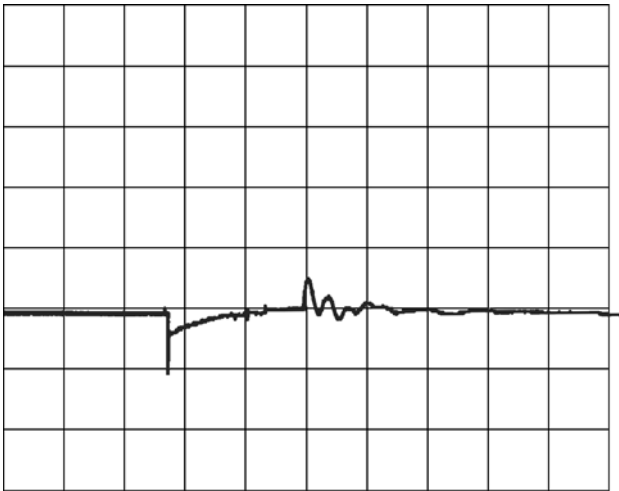

make with pre-contacts (B&J\Oszi10)

K3-18NK 12.5kVAr (18A / 400V)

vertical: **100A** / div horizontal: 1ms / div

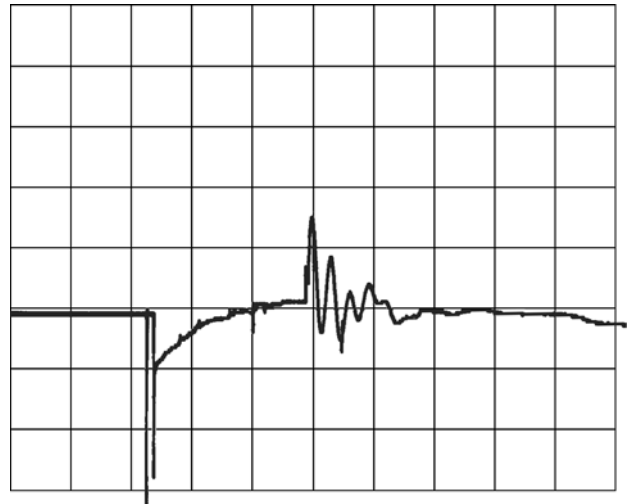

Description:

The difference of the diagrams is the current scale only.

First current peak due to make of pre-contacts.

Second current peak due to building-up the main-circuit with notable lower amplitude as the first and not so steep, that means lower frequency.

Description

make **with** pre-contacts (B&J\Oszi13)

K3-18NK 12.5kVAr (18A / 400V)

vertical: 250A / div horizontal: 0.5ms / div

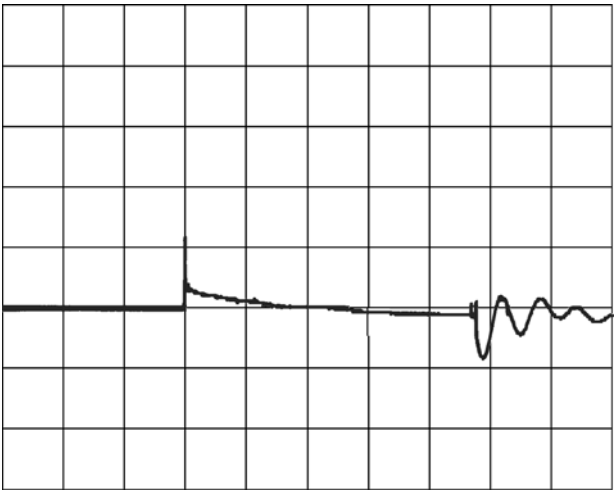

make **without** pre-contacts (B&J\Oszi12)

K3-18ND 12.5kVAr (18A / 400V)

vertical: 250A / div horizontal: 0.5ms / div

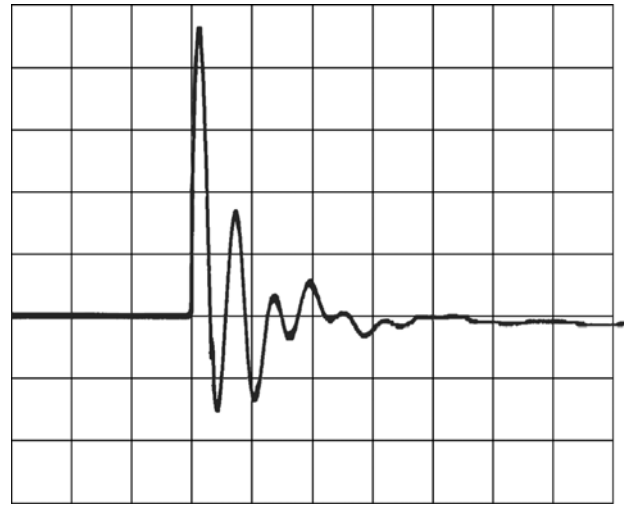

The right picture shows a make current peak without pre-contacts with about 1200A with high power in opposite to 280A with low power (power = integrated area).

Of course, the contactors endure a few switches without pre-contacts.

Switching of capacitor banks at different conditions

make **without** pre-contacts (B&J\Oszi16)
without chokes

K3-62A 50kVAr (72A / 690V)

vertical: **2000A** / div horizontal: 0.625ms / div

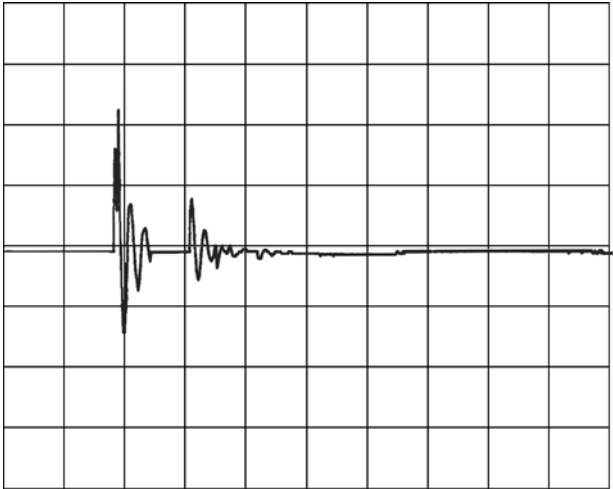

make **without** pre-contacts (B&J\Oszi15)
with chokes

K3-62A 50kVAr (72A / 690V)

vertical: **200A** / div horizontal: 10ms / div

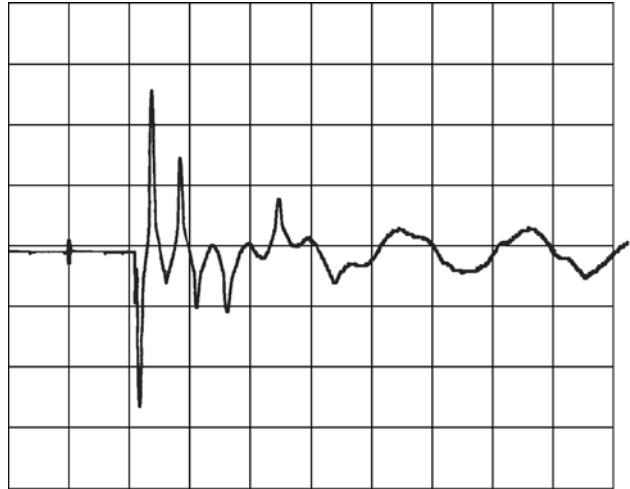

make **with** pre-contacts (B&J\Oszi14)
with chokes

K3-62K 50kVAr (72A / 690V)

vertical: **200A** / div horizontal: 10ms / div

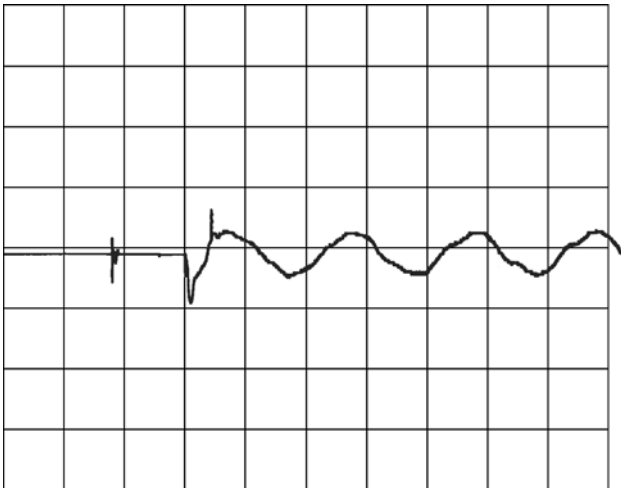

The make current peak without pre-contacts and without chokes is higher than 4000A.

This peak can be reduced by the influence of chokes to approx. 500A.

In the last case we see the influence of chokes and pre-contacts of the "capacitor contactor". The peak is reduced to approx. 200A.

Also the sinus-weave is very clear by the influence of chokes because you have reduced harmonic frequencies.

Notice:



D385E151



Lieblgasse 7, A-1220 Vienna
Phone: +43 1 251 51-0
Fax: +43 1 251 51-89
e-mail: sales@benedict.at
www.benedict.at

