

article#	<b>4142-6f78</b>
article description	<b>CEE-flanged socket sloping (70x85mm) 16A 4p 6h IP67</b>
description long	CEE-flanged socket sloping (70x85mm) 16A4p6h IP67 housing material: PA6 rated current: 16A number of poles: 4 (3P+PE) clock-position: 6h rated voltage/frequency: 380-415V~ / 50+60Hz contacts: brass connection technology: screw terminals dimensions (flange/fixing center): 70x85 mm / 50x65 mm IP protection class: IP67
GTIN (EAN)	9003399620485
country of origin	AT
customs number	85366990
net weight	0.132 kg
packaging quantity	10
minimum order quantity	10

ETIM 9.0	EC001317
IEC-amperage	16 A
Voltage according to EN 60309-2	400 V (50+60 Hz) red
Number of poles	4
Clock hour position	6 h
Identification colour	Red
Degree of protection (IP)	IP67
Connection system	Screwed terminal
Angle of plug	Angled
Material	Plastic
Contact material	CuZn
Surface treatment contacts	Untreated
Flange size vertical	85 mm
Drill hole distance vertical	65 mm
Flange size horizontal	70 mm
Drill hole distance horizontal	50 mm

a	70 mm
b	85 mm
c	50 mm
d	65 mm
e	38 mm
f	52 mm
g	56 mm
h	67 mm
i	5,5 mm
j	104 mm
k	111 mm
wire flexible	1-2,5 mm <sup>2</sup>
wire solid	1-4 mm <sup>2</sup>
contact screws	100 Ncm
dismantling length	50 mm
stripping length	10-12 mm
ambient temperature	-25 – 40 °C
temperature resistance	-25 – 80 °C

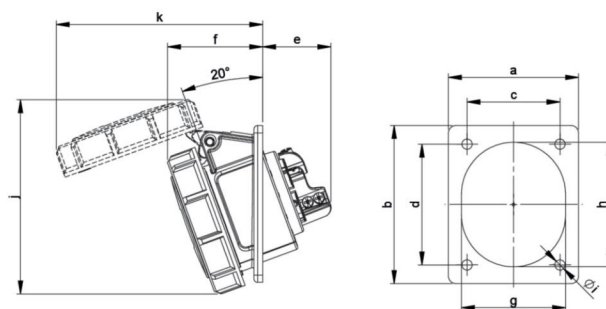

<https://www.pcelectric.at/shop/en/?func=detail&artnr=4142-6f78>

