

article#	4242-6f78
article description	CEE-flanged socket sloping (80x97mm) 32A 4p 6h IP67
description long	CEE-flanged socket sloping (80x97mm) 32A4p 6h IP67 housing material: PA6 rated current: 32A number of poles: 4 (3P+PE) clock-position: 6h rated voltage/frequency: 380-415V~ / 50+60Hz contacts: brass connection technology: screw terminals dimensions (flange/fixing center): 80x97 mm / 60x73 mm IP protection class: IP67
GTIN (EAN)	9003399599729
country of origin	AT
customs number	85366990
net weight	0.224 kg
packaging quantity	10
minimum order quantity	10

ETIM 9.0	EC001317
IEC-amperage	32 A
Voltage according to EN 60309-2	400 V (50+60 Hz) red
Number of poles	4
Clock hour position	6 h
Identification colour	Red
Degree of protection (IP)	IP67
Connection system	Screwed terminal
Angle of plug	Angled
Material	Plastic
Contact material	CuZn
Surface treatment contacts	Untreated
Flange size vertical	97 mm
Drill hole distance vertical	73 mm
Flange size horizontal	80 mm
Drill hole distance horizontal	60 mm

a	80 mm
b	97 mm
c	60 mm
d	73 mm
e	48 mm
f	59 mm
g	65 mm
h	75 mm
i	5,5 mm
j	120 mm
k	127 mm
wire flexible	2,5-6 mm ²
wire solid	2,5-10 mm ²
contact screws	110 Ncm
dismantling length	50 mm
stripping length	12-14 mm
ambient temperature	-25 – 40 °C
temperature resistance	-25 – 80 °C

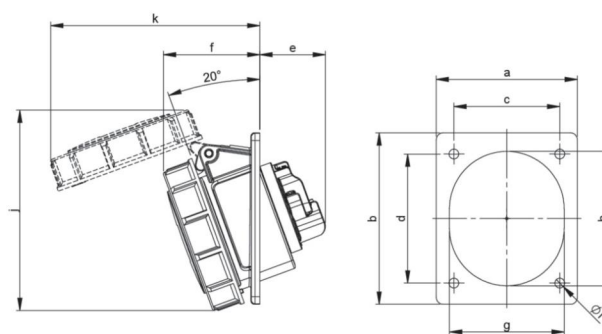





<https://www.pcelectric.at/shop/en/?func=detail&artnr=4242-6f78>

