

article#	9432001
article description	Connector-3way 3x16/3 Plug16/3 6h IP67
description long	Connector-3way 3x16/3 Plug16/3 6h IP67 housing material: PC/ABS rated current: 16A number of poles: 3 (2P+PE) clock-position: 6h rated voltage/frequency: 200-250V~ / 50+60Hz contacts: brass nickel plated Entry: 1x CEE-plug 16A 3p 6h Outlet: 3x CEE-socket 16A 3p 6h ready wired IP protection class: IP67
GTIN (EAN)	9003399049699
country of origin	AT
customs number	85366990
net weight	0.583 kg
packaging quantity	5
minimum order quantity	5

ETIM 9.0	EC000379
CEE socket outlet 16 A	3x16A3p230V
Protection	None
Material housing	Plastic
Contact material	CuZn
Power supply/connection possibility	Built-up plug
Number of poles mains connection	3
Type of mains connection	CEE 16 A
Handling	Portable
Degree of protection (IP)	IP67
Colour	Grey

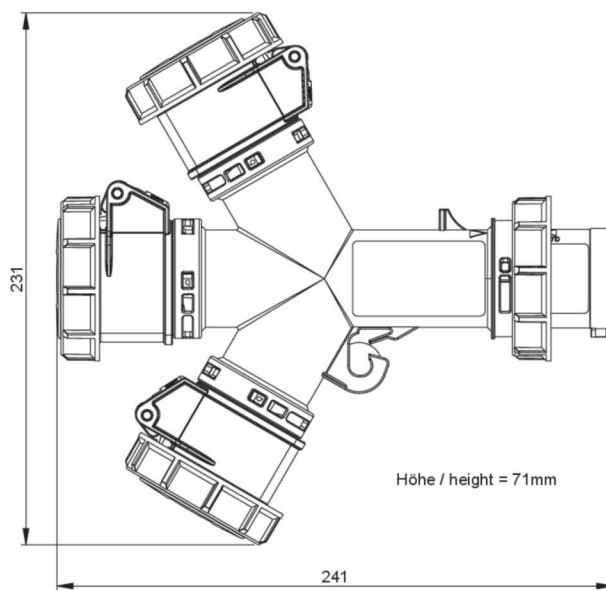





<https://www.pcelectric.at/shop/en/?func=detail&artnr=9432001>

