

article#	9432007
article description	Connector 3-way 3x16/3 6h IP67
description long	Connector 3-way 3x16/3 6h IP67 housing material: PC/ABS rated current: 16A number of poles: 3 (2P+PE) clock-position: 6h rated voltage/frequency: 200-250V~ / 50+60Hz contacts: brass nickel plated cable gland, terminal 3x2,5mm ² Outlet: 3x CEE-socket 16A 3p 6h ready wired to terminal IP protection class: IP67
GTIN (EAN)	9003399050275
country of origin	AT
customs number	85366990
net weight	0.537 kg
packaging quantity	5
minimum order quantity	5

ETIM 9.0	EC000379
CEE socket outlet 16 A	3x16A3p230V
Protection	None
Material housing	Plastic
Contact material	CuZn
Power supply/connection possibility	1 cable (branch line)
Number of poles mains connection	3
Diameter cable entry	Other
Handling	Portable
Degree of protection (IP)	IP67
Colour	Grey

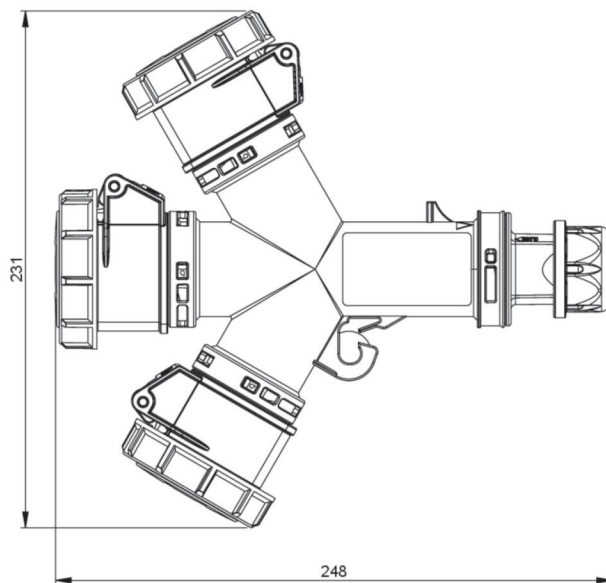





<https://www.pcelectric.at/shop/en/?func=detail&artnr=9432007>

