



for a greener tomorrow



**MITSUBISHI
ELECTRIC**

Changes for the Better

FACTORY AUTOMATION

ELECTRONIC MULTI-MEASURING INSTRUMENT ME96SS



SS Ver.A
Super-S Series

ME96 Super-S Series

Electronic Indicating Instruments functions and optional units

Highly appreciated ME96SS Series Electronic Multi-Measuring Instruments measuring functions and network capability has been released.

This new series has improved measuring accuracy; even the economy model MODBUS[®] TCP communication unit for Ethernet communication and logging will be helpful in realizing more effective measurement monitoring systems

① ME96SSEA-MB (economy model)

Major features

- [1] Active energy measuring accuracy of class 0.5S
- [2] Applicable to harmonics (THD)
- [3] Applicable to current demand

② ME96SSRA-MB (standard model)

Major features

- [1] Active energy measuring accuracy of class 0.5S
- [2] Applicable to harmonics of $\pm 1.0\%$ (19th)
- [3] Applicable to demands A and W,var,VA
- [4] Optional units can be added.

③ ME96SSHA-MB (high-performance model)

Major features

- [1] Active energy measuring accuracy of class 0.5S
- [2] Applicable to harmonics of $\pm 1.0\%$ (31st)
- [3] Applicable to demands A and W,var,VA
- [4] Optional units can be added.

with enhanced measuring

have been remodeled, and ME96 Super-S Series  with enhanced

has an active energy measuring accuracy corresponding to Class 0.5S. The unit for enhanced data backup can be added to the models. The new series and energy-saving measurement monitoring.

④ Optional plug-in modules

Major features

- [1] MODBUS® TCP communication unit **NEW**
- [2] Data logging unit **NEW**
- [3] CC-Link communication unit
- [4] Digital input and output unit
- [5] Analog, pulse and alarm output unit

Remarks

MODBUS® RTU communication function provided as standard

Contents

■ Outline and Features	3
■ ME96 Super-S Series Ver.A Features	4
■ Specifications	9
■ Operating Instructions	14
■ External Dimensions, Installation and Connections	27
■ Related Products	31
■ Safety Precautions	33

Outline and Features

Improved Measurement Functions

- Improved accuracy of active energy, reactive energy and power factor and expanded measurement ranges of harmonics and demand values have been realized.



Model name	Transmission/Option specifications	Main measurement items
ME96SSHA-MB (High-performance class)	MODBUS® RTU communication Plug-in module (options) <ul style="list-style-type: none"> Analog/Pulse/Contact output/input CC-Link communication Digital input/output (for MODBUS® RTU communication) Backup (on SD card) MODBUS® TCP communication 	A, DA, V, Hz = $\pm 0.1\%$ W, var, VA, PF = $\pm 0.2\%$ Wh = class 0.5S (IEC62053-22) varh = class 1S (IEC62053-24) Harmonics = 31 st -deg (max) Rolling demand = W, var, VA
ME96SSRA-MB (Standard class)	MODBUS® RTU communication Plug-in module (options) <ul style="list-style-type: none"> Analog/Pulse/Contact output/input CC-Link communication Digital input/output (for MODBUS® RTU communication) Backup (on SD card) MODBUS® TCP communication 	A, DA, V = $\pm 0.2\%$ Hz = $\pm 0.1\%$ W, var, VA, PF = $\pm 0.5\%$ Wh = class 0.5S (IEC62053-22) varh = class 1S (IEC62053-24) Harmonics = 19 th -deg (max) Rolling demand = W, var, VA
ME96SSEA-MB (Economy class)	MODBUS® RTU communication	A, DA, V = $\pm 0.5\%$ Hz = $\pm 0.2\%$ W, PF = $\pm 0.5\%$ Wh = class 0.5S (IEC62053-22) Harmonics = Only total

Optional Plug-in Modules

Model name	Analog output	Pulse/Alarm output	Contact input	Contact output	Transmission function	Used with
ME-4210-SS96	4	2	1	—	—	ME96SSHA-MB ME96SSRA-MB
ME-0040C-SS96	—	—	4	—	CC-Link	
ME-0052-SS96	—	—	5	2	—	
ME-0000BU-SS96	—	—	—	—	SD CARD	
ME-0000MT-SS96	—	—	—	—	MODBUS® TCP	

Note: Optional Plug-in Module can not be used with ME96SSEA-MB.

MODBUS® RTU System (ME96SSHA-MB/ME96SSRA-MB with ME-0052-SS96 (optional plug-in module))

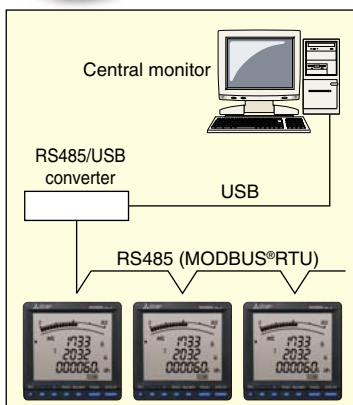

- MODBUS® RTU communication system optimizes computer monitoring operations
- Attachment of ME-0052-SS96 (optional) enables remote monitoring of the contact input signal and on/off control of the contact output signal
- Digital input signals can be latched for over 30ms, and there is no need for external latch circuits

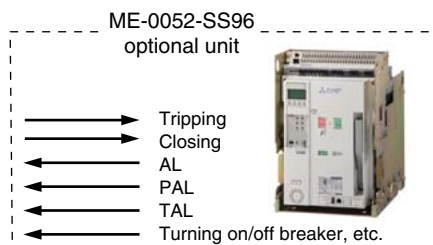

<MODBUS® RTU Interface Specifications>

- Max. Baud rate: 38.4kbps
- Max. Connection Distance: 1,200m
- Max. Connection Units: 31

<Optional Plug-in Module ME-0052-SS96>

- Digital Input: 5 points (24VDC)
- Digital Output: 2 points (35VDC)

ME96 Super-S Series Ver.A Features

CC-Link System (ME96SSHA-MB/ME96SSRA-MB with ME-0040C-SS96 (optional plug-in module))

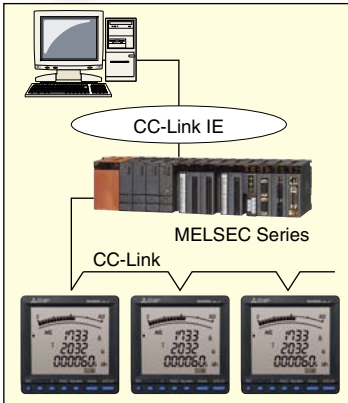

- Optimum transmission system for remote monitoring using Mitsubishi PLC
- Contact signals can be remotely monitored by installing the optional module ME-0040C-SS96. This is helpful in wiring and space saving.
- Digital unit signal can be latched for over 30ms, and there is no need for external latch circuits

- ← Abnormal Signal (Facility)
- ← Abnormal Signal (Earth Leakage)
- ← Abnormal Signal (Temperature)
- ← Circuit Breaker Status Signal, etc.

<CC-Link Interface>

- Max. Baud rate: 10Mbps
- Max. Connection Distance: 100m (10Mbps)~1,200m (156kbps)
- Max. Connection Units: 42
- Digital Input: 4 points (24VDC)

Analog/Pulse/Alarm Output System (ME96SSHA-MB/ME96SSRA-MB with ME-4210-SS96 (optional plug-in module))

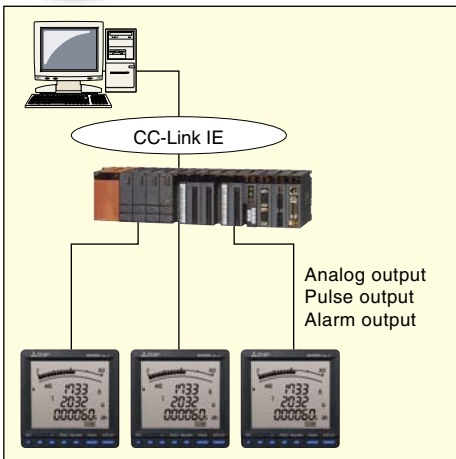

- Applicable to analog output, pulse output and alarm output with the aid of the optional module ME-4210-SS96
- Remote monitoring of A, DA, V, W, var, VA, PF, Hz, Harmonics Current RMS value and Harmonics voltage RMS value at 4 to 20mA output (max. 4 outputs)
- Active energy, reactive energy, apparent power and periodic energy (ME96SSHA-MB) can be monitored by pulse output (max. 2 pulses)
- Can remotely monitor upper/lower limit alarm by contact output (max. 2 points)

<Analog output specifications>

- 4-20mA
- 4 outputs
- Resistance load 600Ω or less

<Pulse output specifications>

- No-voltage a contact point
- 35VDC, 0.1A
- Select output from pulse widths of 0.125, 0.5 or 1s

<Alarm output specifications>

- No-voltage a contact point
- 35VDC, 0.1A

<Digital input specifications>

- 1 point (24VDC)

MODBUS® TCP Communication (ME96SSHA-MB/ME96SSRA-MB with ME-0000MT-SS96 (optional plug-in module))

- There is available an optional module usable not only for the conventional MODBUS® RTU (RS-485) communication and CC-Link communication, but also for MODBUS® TCP communication in an Ethernet environment.

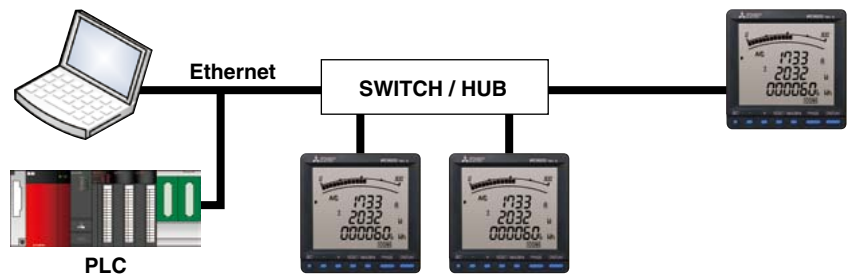

Data Logging (ME96SSHA-MB/ME96SSRA-MB with ME-0000BU-SS96 (optional plug-in module))

- There is available an optional module which can retain data even when communication cannot be established.

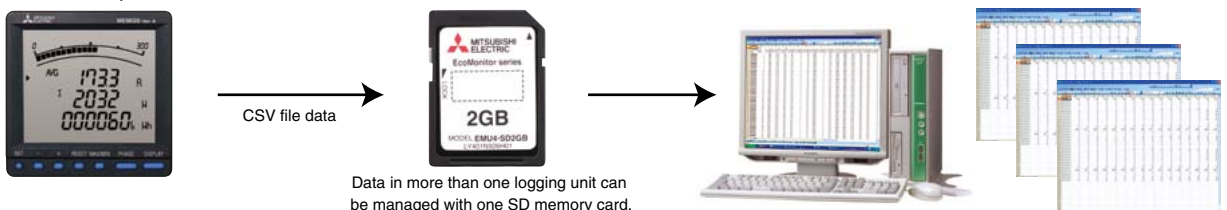

Data in more than one logging unit can be managed with one SD memory card.

Note: Use the SD memory card (EMU4-SD2GB) made by Mitsubishi Electric.

Use of any memory card other than our product (EMU4-SD2GB) is not covered by the warranty.

ME96 Super-S Series Ver.A Features



Succeeded Display Functions

Large Bar Graph Display Special

● Bar Graph Display

Each measuring items can be displayed by a bar graph. With bar graph display, one can grasp the rated value and percentage against the alarm value instantly.

(1) Bar Graph Fixed Display

Measuring items can be displayed by bar graph. The \uparrow mark indicates that display is fixed. Furthermore, the \oplus and \ominus buttons can be used to change the display between items measured.

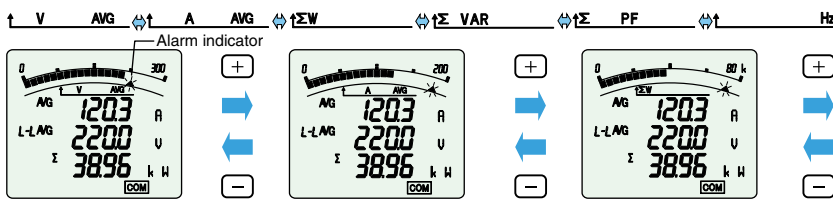

Note: Alarm indicator blinks when it is set on alarm mode.

(2) Digital Values Display by Bar Graph

Values on the tri-level digital display can be shown by bar graphs (Except when the tri-level display is measuring the same items). Bar graph shows the digital value of \blacktriangleright

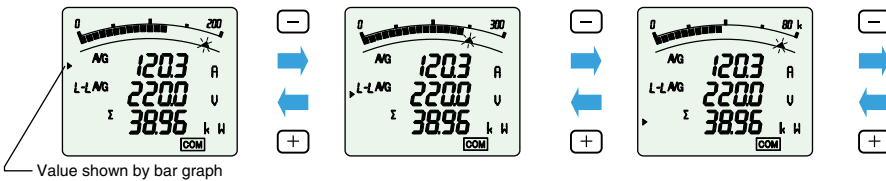

Value shown by bar graph

Special Display Function

● Special Display by Display Pattern P00

Display can be selected as desired Display Pattern P00.

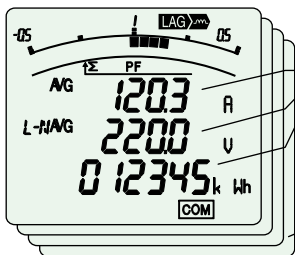

Upper/Middle/Lower levels: Select from A, DA, V, W, var, VA, PF, Hz, Wh, -Wh, varh, VAh

Maximum of four displays can be set

Max/Min Display Function

● Maximum/Minimum Value Display

The maximum and minimum value of each measuring items can be displayed. Since the max/min display shows the current value as well as max/min values, the display can be used for monitoring. Also, range of minimum value to maximum value is shown by bar graph.

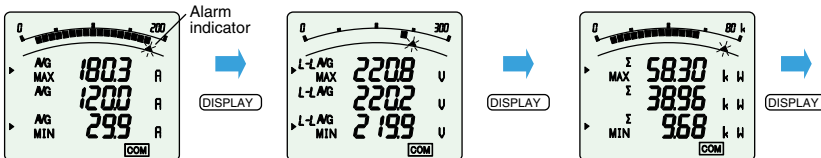

High-brightness Backlight

- High-reliability and high-brightness backlight is built in
- Backlight brightness can be adjusted from level 1 to 5 (default setting is 3)
- "Always-on mode" or "Automatic off mode" can be selected (default setting is automatic off mode)



ME96NS Series



ME96SS Series



Impressive Monitoring Functions

Advanced Alarm Display

- (1) A function to blink the backlight upon occurrence of an alarm is provided.
On the conventional models, the display was lit up upon occurrence of an alarm. The new product has a setting function to blink the backlight upon occurrence of an alarm.
- (2) As with the conventional models, the automatic or manual alarm cancel mode can be selected.
- (3) As with the conventional models, up to four points of upper and lower limits can be monitored.
- (4) The alarm output delay time (alarm mask time) can be set.
Time of alarm output after the maximum value and minimum value is reached can be set.
With this function, alarm output caused by frequency change at start-up current of a motor and start-up of private power generating facility can be avoided.

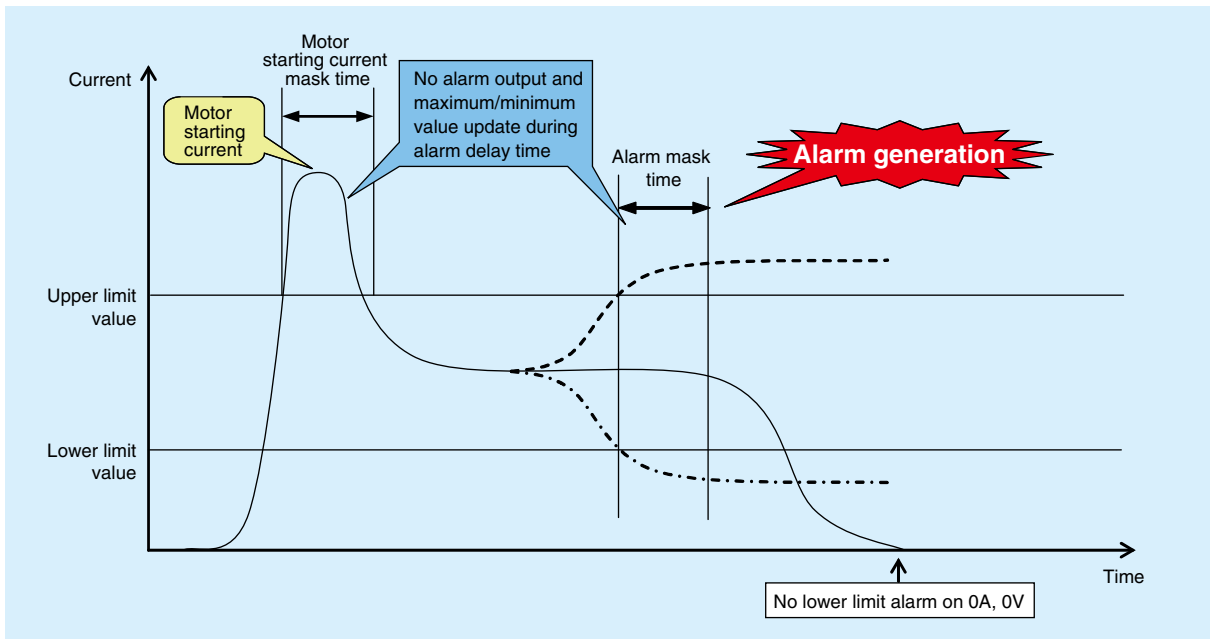

Motor Starting Current Mask Function

The use of the motor starting current mask function for monitoring the motor current can prevent updating of the maximum value and alarm output caused by the motor starting current.

Although the maximum value is not updated, the current value is displayed.

The starting current mask time can be set in the range from 1s to 5min.

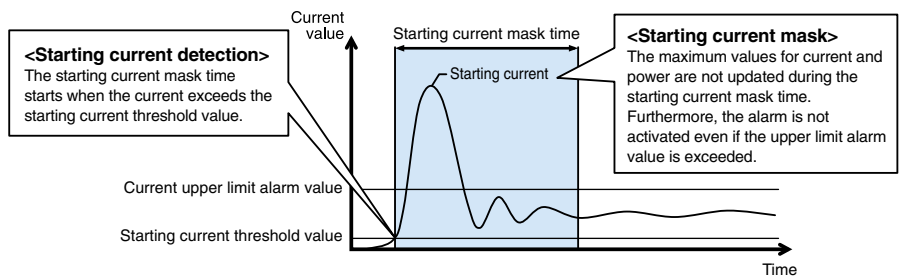

Note: Set the starting current threshold to a value lower than the lower limit value in consideration of fluctuations in load current during operation.

ME96 Super-S Series Ver.A Features

Variety of Complementary Features

Password Function

With the password function, the following items can be protected from an accidental execution.

No.	Password-protected item	No.	Password-protected item
1	Shift to the setting mode	5	Adjust the time limit of rolling demand
2	Reset the max./min. values	6	Reset the peak value of rolling demand
3	Reset the value of active energy, reactive energy and apparent energy	7	Reset the value of operating time
4	Reset the value of periodic active energy		

Special Primary Voltage/Current and Special Secondary Voltage are settable

(1) Special primary current

1A~30kA

Under 10A: Top two digits setting
Over 10A: Top three digits setting



(2) Special primary voltage

60V~750kV

Under 100V: Top two digits setting
Over 100V: Top three digits setting



(3) Special secondary voltage

Three phase 4-wire system

{ 63.5V, 100V, 110V, 115V, 120V }

Three phase 3-wire, Single phase 2-wire system

{ 100V, 110V, 220V }



Periodic Monitoring Function

Power consumption can be measured in two individual intervals (e.g., peak/off-peak, day/night, etc.).

The time segments can be switched according to the setting via communication or the digital input (DI).

(The time segments cannot be switched manually (button operation).)



Power consumption (period 1)



Power consumption (period 2)

Rolling Demand Function

Rolling demand is the estimated power consumption in a specified period (interval).

For the block interval demand, select the duration (interval) of the block to be used for demand calculation.

① Rolling block

Use rolling block to set the interval and sub-intervals from 1~60min (1min intervals). Rolling demand is calculated and updated at the end of each sub-interval.

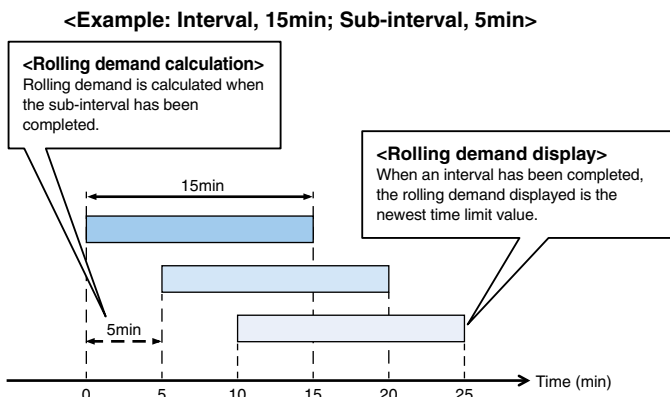

② Fixed block

Use fixed block to set the interval from 1~60min (1min intervals). Rolling demand is calculated and updated at the end of each interval. (For fixed block, use the same time limits both of interval and sub-interval).

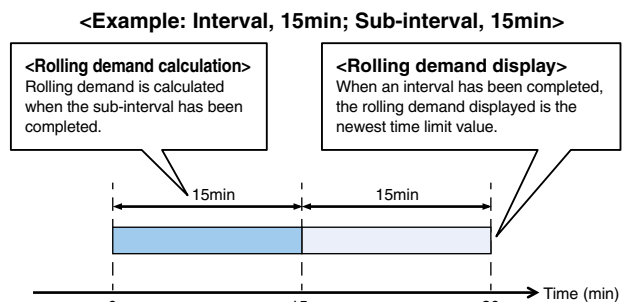



Test Function

- A test function is provided to check the wiring for communication, alarm output/contact output, analog output and pulse output without input of voltage or current.
- At the time of wiring test before shipment of the board and counter test for system validation on site, test signals can be output only by applying the auxiliary power.

Note: Depending on the optional unit and settings, the test function may not be available (may not be displayed).

(1) Communications Test

① Display

- The same as for the operating mode, display patterns and other data are shown as set.
- Both maximum and minimum values can be displayed.

② Communication data

- Communication items and value are the same one on the display. The items value that are not displayed is 0 (zero).
- Measuring items set for alarm will be displayed at the time of an alarm.
- Input/Output contact status can be monitored.



(2) Alarm/Contact Output Operation Test

- ① Displays current alarm and contact status.
- ② Press the Reset button for 2sec, and regardless if there is an alarm or not, the display and contact output will operate as follows.

Status	Display	Output terminal
Alarm	ON	Open
No alarm	OFF	Closed



(3) Analog Output Operation Test

- ① Display the output items.
- ② Press the (+) or (-) button to change the analog output.

Note: Default value is 0%.

Output	Output specs
	4-20mA
0%	4mA
25%	8mA
50%	12mA
75%	16mA
100%	20mA

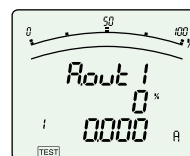

(4) Pulse Output Operation Test

Press the Reset button one time to output one pulse.

Note: After reaching 50, count will return to 1.

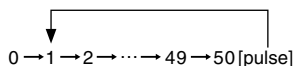

Note: Default value is 0 pulses.

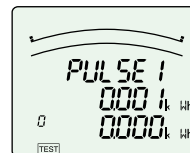

Standards

All products are compliant with CE Marking, UL Standards, KC mark and FCC/IC.

Specifications

ME96SSHA-MB

Model name		ME96SSHA-MB	
Phase wire		Three phase 4-wire, Three phase 3-wire (3CT, 2CT), Single phase 3-wire, Single phase 2-wire (common use)	
Rating	Current	5AAC, 1AAC (common use)	
	Voltage	Three phase 4-wire: 277/480VAC (max) Three phase 3-wire: Delta connections: 220VAC (max), Star connections: 440VAC (max) Single phase 3-wire: 220/440VAC (max) Single phase 2-wire: Delta connections: 220VAC (max), Star connections: 440VAC (max)	
	Frequency	50-60Hz (common use)	
		Measurement items	Class
Measurement items and accuracy	Current (A)	A1, A2, A3, AN, A _{AVG}	±0.1%
	Current demand (DA)	DA1, DA2, DA3, DAN, DA _{AVG}	±0.1%
	Voltage (V)	V12, V23, V31, V _{AVG} (L-L) V1N, V2N, V3N, V _{AVG} (L-N)	±0.1%
	Active power (W)	W1, W2, W3, Σ W	±0.2%
	Reactive power (var)	var1, var2, var3, Σ var	±0.2%
	Apparent power (VA)	VA1, VA2, VA3, Σ VA	±0.2%
	Power factor (PF)	PF1, PF2, PF3, Σ PF	±0.2%
	Frequency (Hz)	Hz	±0.1%
	Active energy (Wh)	Imported, Exported	class 0.5S (IEC62053-22)
	Reactive energy (varh)	Imported lead, lag Exported lead, lag	class 1S (IEC62053-24)
	Apparent energy (Vah)	—	±2.0%
	Harmonic current (HI)	Total, 1 st to 31 st degree (odd number degree only)	±1.0%
	Harmonic voltage (HV)	Total, 1 st to 31 st degree (odd number degree only)	±1.0%
	Rolling demand (DW)	Rolling block, fixed block	±0.2%
	Rolling demand, reactive power (Dvar)	Rolling block, fixed block	±1.0%
	Rolling demand, apparent power (DVA)	Rolling block, fixed block	±1.0%
	Periodic Active energy (Wh)	Periodic active energy 1, 2	class 0.5S (IEC62053-22)
Operating time	Operating time 1, 2	(Reference)	
Analog output response time		2s or less (HI, HV: 10s or less)	
Measuring method	Instantaneous value	A/V: RMS calculation, W/ var/ VA/ Wh/ varh/ VAh: Digital multiplication, PF: Power ratio calculation, Hz: Zero-cross, HI/HV: FFT	
	Demand value	DA: Thermal type calculation DW, Dvar, DVA: Rolling demand calculation	
Display	Indicator		LCD with LED backlight
	No. of display digits and segments	Digital display	6 digits each at upper, middle, and lower line A, DA, V, W, var, VA, PF, DW, Dvar, DVA: 4 digits Hz: 3 digits Wh, varh, VAh: 9 digits (6 or 12 possible) Harmonic distortion ratio, content ratio: 3 digits Harmonic RMS: 4 digits Operating time: 6 digits Contact input/output: I/O
		Bar graph	21 segment bar graph, 22 segment indicator
	Display updating time interval		0.5s or 1s (selectable)
Communication		MODBUS [®] RTU communication	
Available optional plug-in module		ME-4210-SS96 ME-0000BU-SS96 ME-0040C-SS96 ME-0000MT-SS96 ME-0052-SS96	
Power failure compensation		Non-volatile memory used (items: setting value, max/min value, active/reactive energy, apparent energy, periodic active energy, rolling demand, operating time)	
Consumption (VA)	VT	Each phase 0.1VA (110VAC), 0.2VA (220VAC), 0.4VA (440VAC)	
	CT	Each phase 0.1VA (5AAC)	
	Auxiliary power circuit	7VA (at 110VAC), 8VA (at 220VAC), 5W (at 100VDC)	
Auxiliary power		100-240VAC (±15%), 100-240VDC (-30% +15%)	
Weight		0.5kg	
Dimensions		96 (H) × 96 (W) × 90 (D)	
Installation method		Embedded	
Operating temperature		-5~+55°C (average operating temperature: 35°C or less per day)	
Operating humidity		0~85% RH (non condensing)	
Storage temperature		-25~+75°C (average temperature: 35°C or less per day)	
Storage humidity		0~85% RH (non condensing)	

Notes 1. Class values based on 100% of rated value.

Notes 2. Harmonic measurements where distortion ratio (content rate) is 100% or more may exceed ±1.0%.

Notes 3. Harmonic current cannot be measured without voltage input.



ME96SSRA-MB

Model name		ME96SSRA-MB	
Phase wire		Three phase 4-wire, Three phase 3-wire (3CT, 2CT), Single phase 3-wire, Single phase 2-wire (common use)	
Rating		Current	5AAC, 1AAC (common use)
		Voltage	Three phase 4-wire: 277/480VAC (max) Three phase 3-wire: Delta connections: 220VAC (max), Star connections: 440VAC (max) Single phase 3-wire: 220/440VAC (max) Single phase 2-wire: Delta connections: 220VAC (max), Star connections: 440VAC (max)
		Frequency	50-60Hz (common use)
		Measurement items	Class
Measurement items and accuracy	Current (A)	A1, A2, A3, AN, A _{AVG}	±0.2%
	Current demand (DA)	DA1, DA2, DA3, DAN, DA _{AVG}	±0.2%
	Voltage (V)	V12, V23, V31, V _{AVG} (L-L) V1N, V2N, V3N, V _{AVG} (L-N)	±0.2%
	Active power (W)	W1, W2, W3, ΣW	±0.5%
	Reactive power (var)	var1, var2, var3, Σvar	±0.5%
	Apparent power (VA)	VA1, VA2, VA3, ΣVA	±0.5%
	Power factor (PF)	PF1, PF2, PF3, ΣPF	±0.5%
	Frequency (Hz)	Hz	±0.1%
	Active energy (Wh)	Imported, Exported	class 0.5S (IEC62053-22)
	Reactive energy (varh)	Imported lead, lag Exported lead, lag	class 1S (IEC62053-24)
	Apparent energy (Vah)	—	±2.0%
	Harmonic current (HI)	Total, 1 st to 19 th degree (odd number degree only)	±1.0%
	Harmonic voltage (HV)	Total, 1 st to 19 th degree (odd number degree only)	±1.0%
	Rolling demand (DW)	Rolling block, fixed block	±0.5%
	Rolling demand, reactive power (Dvar)	Rolling block, fixed block	±1.0%
	Rolling demand, apparent power (DVA)	Rolling block, fixed block	±1.0%
	Periodic Active energy (Wh)	Periodic active energy 1, 2	class 0.5S (IEC62053-22)
Operating time	Operating time 1, 2	(Reference)	
Analog output response time		2s or less (HI, HV: 10s or less)	
Measuring method		Instantaneous value	A/V: RMS calculation, W/var/VA/Wh/varh: Digital multiplication, PF: Power ratio calculation, Hz: Zero-cross, HI/HV: FFT
		Demand value	DA: Thermal type calculation DW, Dvar, DVA: Rolling demand calculation
Display	Indicator		LCD with LED backlight
	No. of display digits and segments	Digital display	6 digits each at upper, middle, and lower line A, DA, V, W, var, VA, PF, DW, Dvar, DVA: 4 digits Hz: 3 digits Wh, varh: 9 digits (6 or 12 possible) Harmonic distortion ratio, content ratio: 3 digits Harmonic RMS: 4 digits Operating time: 6 digits Contact input/output: I/O
		Bar graph	21 segment bar graph, 22 segment indicator
	Display updating time interval		0.5s or 1s (selectable)
Communication		MODBUS [®] RTU communication	
Available optional plug-in module		ME-4210-SS96 ME-0000BU-SS96 ME-0040C-SS96 ME-0000MT-SS96 ME-0052-SS96	
Power failure compensation		Non-volatile memory used (items: setting value, max/min value, active/reactive energy, apparent energy, periodic active energy, rolling demand, operating time)	
Consumption (VA)	VT	Each phase 0.1VA (110VAC), 0.2VA (220VAC), 0.4VA (440VAC)	
	CT	Each phase 0.1VA (5AAC)	
	Auxiliary power circuit	7VA (at 110VAC), 8VA (at 220VAC), 5W (at 100VDC)	
Auxiliary power		100-240VAC (±15%), 100-240VDC (-30% +15%)	
Weight		0.5kg	
Dimensions		96 (H) × 96 (W) × 90 (D)	
Installation method		Embedded	
Operating temperature		-5~+55°C (average operating temperature: 35°C or less per day)	
Operating humidity		0~85% RH (non condensing)	
Storage temperature		-25~+75°C (average temperature: 35°C or less per day)	
Storage humidity		0~85% RH (non condensing)	

Notes 1. Class values based on 100% of rated value.

Notes 2. Harmonic measurements where distortion ratio (content rate) is 100% or more may exceed ±1.0%.

Notes 3. Harmonic current cannot be measured without voltage input.

Specifications

ME96SSEA-MB

Model name		ME96SSEA-MB	
Phase wire		Three phase 4-wire, Three phase 3-wire (3CT, 2CT), Single phase 3-wire, Single phase 2-wire (common use)	
Rating	Current	5AAC, 1AAC (common use)	
	Voltage	Three phase 4-wire: 277/480VAC (max) Three phase 3-wire: Delta connections: 220VAC (max), Star connections: 440VAC (max) Single phase 3-wire: 220/440VAC (max) Single phase 2-wire: Delta connections: 220VAC (max), Star connections: 440VAC (max)	
	Frequency	50-60Hz (common use)	
		Measurement items	Class
Measurement items and accuracy	Current (A)	A1, A2, A3, AN, A _{AVG}	±0.5%
	Current demand (DA)	DA1, DA2, DA3, DAN, DA _{AVG}	±0.5%
	Voltage (V)	V12, V23, V31, V _{AVG} (L-L) V1N, V2N, V3N, V _{AVG} (L-N)	±0.5%
	Active power (W)	W1, W2, W3, ΣW	±0.5%
	Reactive power (var)	—	—
	Apparent power (VA)	—	—
	Power factor (PF)	PF1, PF2, PF3, ΣPF	±0.5%
	Frequency (Hz)	Hz	±0.2%
	Active energy (Wh)	Receiving	class 0.5S (IEC62053-22)
	Reactive energy (varh)	—	—
	Apparent energy (Vah)	—	—
	Harmonic current (HI)	Total	±2.0%
	Harmonic voltage (HV)	Total	±2.0%
	Rolling demand (DW)	—	—
	Rolling demand, reactive power (Dvar)	—	—
	Rolling demand, apparent power (DVA)	—	—
	Periodic Active energy (Wh)	—	—
Operating time	Operating time 1, 2	(Reference)	
Analog output response time		—	
Measuring method		Instantaneous value	A/V: RMS calculation, W: Digital multiplication, PF: Power ratio calculation, Hz: Zero-cross, HI/HV: FFT
		Demand value	DA: Thermal type calculation
Display	Indicator		LCD with LED backlight
	No. of display digits and segments	Digital display	6 digits each at upper, middle, and lower line A, DA, V, W, PF: 4 digits Hz: 3 digits Wh: 9 digits (6 or 12 possible) Relative harmonic content: 3 digits Harmonic RMS value: 4 digits Operating time: 6 digits
		Bar graph	21 segment bar graph, 22 segment indicator
	Display updating time interval		0.5s or 1s (selectable)
Communication		MODBUS [®] RTU communication	
Available optional plug-in module		—	
Power failure compensation		Non-volatile memory used (items: setting value, max/min value, active energy, operating time)	
Consumption (VA)	VT	Each phase 0.1VA (110VAC), 0.2VA (220VAC), 0.4VA (440VAC)	
	CT	Each phase 0.1VA (5AAC)	
	Auxiliary power circuit	7VA (at 110VAC), 8VA (at 220VAC), 5W (at 100VDC)	
Auxiliary power		100-240VAC (±15%), 100-240VDC (-30% +15%)	
Weight		0.5kg	
Dimensions		96 (H) × 96 (W) × 90 (D)	
Installation method		Embedded	
Operating temperature		-5~+55°C (average operating temperature: 35°C or less per day)	
Operating humidity		0~85%RH (non condensing)	
Storage temperature		-25~+75°C (average temperature: 35°C or less per day)	
Storage humidity		0~85%RH (non condensing)	

Notes 1. Class values based on 100% of rated value.

Notes 2. Harmonic measurements where distortion ratio (content rate) is 100% or more may exceed ±2.0%.



Standards Compliance

Electromagnetic Compatibility	
Emissions	
Radiated Emission	EN61326-1/CISPR 11, FCC Part15 Subpart B Class A
Conducted Emission	EN61326-1/CISPR 11, FCC Part15 Subpart B Class A
Harmonics Measurement	EN61000-3-2
Flicker Meter Measurement	EN61000-3-3
Immunity	
Electrostatic discharge Immunity	EN61326-1/EN61000-4-2
Radio Frequency Electromagnetic field Immunity	EN61326-1/EN61000-4-3
Electrical Fast Transient/Burst Immunity	EN61326-1/EN61000-4-4
Surge Immunity	EN61326-1/EN61000-4-5
Conducted Disturbances, Induced By Radio Frequency Fields Immunity	EN61326-1/EN61000-4-6
Power Frequency Magnetic Field Immunity	EN61326-1/EN61000-4-8
Voltage Dips and Short Interruptions	EN61326-1/EN61000-4-11
Safety	
Europe	CE, as per EN61010-1
U.S. and Canada	cRUus as per UL61010-1, IEC61010-1
Installation Category	III
Measuring Category	III
Pollution Degree	2

MODBUS[®] RTU Communication Specifications

Item	Specification
Interface	RS-485 2-wire half-duplex transmission
Protocol	RTU (binary data transfer)
Transmission method	Asynchronous
Connection type	Multi-point bus
Baud rate	2400, 4800, 9600, 19200, 38400bps
Data bit	8
Stop bit	1, 2
Parity	ODD, EVEN, NONE
Address	1 to 255 (0: for broadcast mode)
Distance	1,200m (max)
Max. connectable units	31 units
Terminal Resistance	120Ω 1/2W
Recommended Cable	Shielded twisted-pair AWG24 to 14

- For more information on data, please refer to the following document.
 - Electronic Multi-Measuring Instrument ME series MODBUS[®] Interface specifications...LMS-0492

CC-Link Communication Specifications

Item	Specification
No. of occupied stations	1 Station Remote device station
CC-Link version	CC-Link Ver 1.10 / Ver 2.00
Baud rate	10Mbps / 5Mbps / 2.5Mbps / 625kbps / 156kbps
Transmission method	Broadcast polling system
Synchronous method	Frame synchronous system
Encoding method	NRZI
Transmission path format	Bus format (EIA RS485)
Transmission format	HDLC
Error control system	CRC ($X^{16} + X^{12} + X^5 + 1$)
Number of connectable units	42 units (max, remote device station)
Remote station numbers (station numbers)	1 to 64

- For CC-Link connection cables, please use the dedicated cables. For information regarding dedicated cables, please refer to the CC-Link Partner Product Catalog published by the CC-Link Partner Association or CC-Link Partner Product Information on the CC-Link Partner Association website (<http://www.cc-link.org>).
 - Notes 1. Dedicated CC-Link cables compatible with Ver. 1.00 cannot be used in tandem with dedicated CC-Link high-performance cables compatible with Ver. 1.00.
 - Notes 2. In the case of systems consisting of units compatible with Ver. 1.00, 1.10 or 2.00 used in tandem with Ver. 1.00 or 1.10 cables, Ver. 1.00 specifications will apply for the maximum total cable length and length of cables between stations.
 - Notes 3. For terminal resistance, be sure to use 110Ω ±5% (1/2W product) when using dedicated CC-Link cables or 130Ω ±5% (1/2W product) when using dedicated CC-Link high-performance cables.
- For more information on data, please refer to the following document.
 - Electronic Multi-Measuring Instrument programming manual (CC-Link).....LEN080334
 - Electronic Multi-Measuring Instrument programming manual (CC-Link)(For ver. 2 remote device station)...LEN130391

Input/Output Specifications

Item	Specification	Optional Plug-in Module type
Analog output	4-20mA (0-600Ω)	ME-4210-SS96
Pulse/Alarm output	No-voltage "a" contact Capacity: 35VDC, 0.1A	ME-4210-SS96
Digital input	19-30VDC 7mA or less	ME-4210-SS96, ME-0040C-SS96, ME-0052-SS96
Digital output	No-voltage a contact Capacity: 35VDC, 0.2A	ME-0052-SS96

Specifications

MODBUS[®] TCP Communication Specifications

Item		Specification
Interface		1 port (10BASE-T/100BASE-TX)
Transmission method		Base band
Number of stages connected in cascade		Max. 4 stages (10BASE-T), max. 2 stages (100BASE-TX) (when repeater hub is used)
Max. distance between nodes		200m
Max. segment length		100m
Connector applicable to external wiring		RJ45
Cable	10BASE-T	Cable meeting IEEE802.3 10BASE-T standard (Unshielded twisted pair cable (UTP cable), category 3 or higher)
	100BASE-TX	Cable meeting IEEE802.3 100BASE-TX standard (Shielded twisted pair cable (STP cable), category 5 or higher)
Protocol		MODBUS [®] TCP (port No.502)
Max. number of connections		4
Support functions		Auto-negotiation function (automatic recognition of 10BASE-T/100BASE-TX) Auto-MDIX function (automatic recognition of straight cable/cross cable)

■ For more information on data, please refer to the following document.
Electronic Multi-Measuring Instrument ME series MODBUS[®] Interface specifications...LMS-0492

Logging Specifications

Item		Specification
Logging mode		Automatic updating by overwriting (not provided with a function to automatically start according to the start time setting)
Kinds of logging data	Detailed data	Measurement data is stored at the specified "detailed data logging interval" (1 min, 5 min, 10 min, 15 min or 30 min). Note: The data will be output as a detailed data file. Note: As the integrated values, not the difference values, but the values displayed on the multi indicating instrument will be output.
	1-hour data	Measurement data is stored at a one-hour interval. Note: The data will be output as a one-hour data file or a one-day data file. Note: As the integrated values, not the difference values, but the values displayed on the multi indicating instrument will be output.
Number of logging elements	Detailed data	Max. 6 elements
	1-hour data	Max. 6 elements
Internal memory logging period	Detailed data	Detailed data logging interval: 1 min for 2 days Detailed data logging interval: 5 min for 10 days Detailed data logging interval: 10 min for 20 days Detailed data logging interval: 15 min for 30 days Detailed data logging interval: 30 min for 60 days
	1-hour data	400 days (about 13 months)
SD memory card (2GB) logging period		10 years or more
System log data		1200 records
Logging data / system log data output format		CSV format (ASCII code)
Power failure compensation		Backup by built-in lithium battery Total power interruption backup time: 5 years (at daily average temperature of 35°C or less) (The life of the lithium battery is 10 years (at a daily average temperature of 35°C or less).) The battery cannot be replaced by the customer. Please consider updating the module.
Set values	(logging ID, logging elements and detailed data logging interval)	Stored in FRAM (non-volatile memory) Note: The data will not be deleted even if power interruption is caused by battery voltage drop (BAT. LED is on).
Logging data and system log data		Stored in SRAM (volatile memory) Note: The data will be deleted if power interruption is caused by battery voltage drop (BAT. LED is on).
Clock operation		Note: The clock operation will stop if power interruption is caused by battery voltage drop (BAT. LED is on). After power restoration, the clock operation will start from 00:00 on Jan. 1, 2016.
Clock accuracy		1 min / month
Output data storage medium		SD memory card (SD or SDHC)
Optional accessory		SD memory card (EMU4-SD2GB) *1

*1: Use the SD memory card (EMU4-SD2GB) made by Mitsubishi Electric.
Use of any memory card other than our product (EMU4-SD2GB) is not covered by the warranty.

■ For more information on data, please refer to the following document.
Logging specifications...LMS-0551

Operating Instructions

Functions

LCD Functions

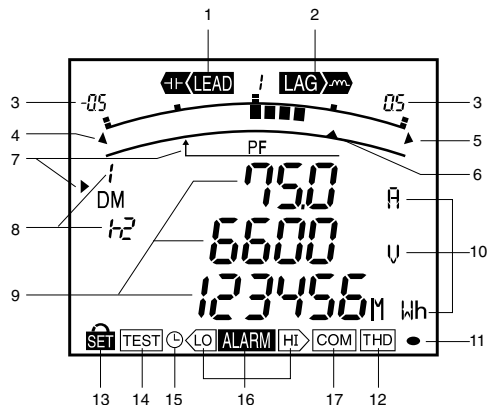

No.	Segment name	Description
1	Lead Status	Power factor status is lead
2	Lag status	Power factor status is lag
3	Scale of the bar graph	The scale of the bar graph
4	Excessively low input	On when the measurement value is lower than the minimum scale value
5	Excessively high input	On when the measurement value is higher than the maximum scale value
6	Upper/lower limit alarm indicator	Flashing when the upper and lower limit alarm values have been set
7	Bar graph status	The item expressed with the bar graph
8	Phase status	The phase for each of the digital displays
9	Digital	The measured value is displayed in a digital number
10	Unit	The unit for each of the digital display
11	Metering status	When it is blinking, the instrument is counting active energy
12	Harmonics	On when harmonics values are displayed
13	Setup status	is on in the test mode. is flashing in the set value check mode.
14	Test status	On in the test mode
15	Clock status	When it is blinking, the instrument is counting operating time
16	Upper/lower limit alarm status	Flashing when upper/lower limit alarm has occurred
17	Communication status	On in normal state, and flashing or off in abnormal state

Button Functions

Basic functions		Special functions	
Button	Functions	Button	Functions
SET	Set up setting items such as primary voltage and current, and choose and indicate setting items	DISPLAY	Push for 2s Manual display change ⇔ Cyclic display change
+ or -	Change setting and bar graph display	PHASE	Push for 2s Manual phase change ⇔ Cyclic phase change
MAX/MIN	Change display from Max/Min to instantaneous value	+ + -	Push for 2s Zoom display of Wh, varh etc
PHASE	Change phase	+ + RESET	Push for 2s Reset all the Max/Min values
DISPLAY	Change display	+ or -	Push for 1s Fast forward or fast return values when setting
		SET + RESET + PHASE	Reset Wh, varh, Vah values to zero by holding down the buttons for 2 sec

Set-up

For correct measurement, it is necessary to set the primary voltage/current in set-up mode.

Access set-up mode from the measurement mode and set the necessary items. Factory default settings will apply to items not set.

Set-up workflow (in the case of ME96SSHA-MB)

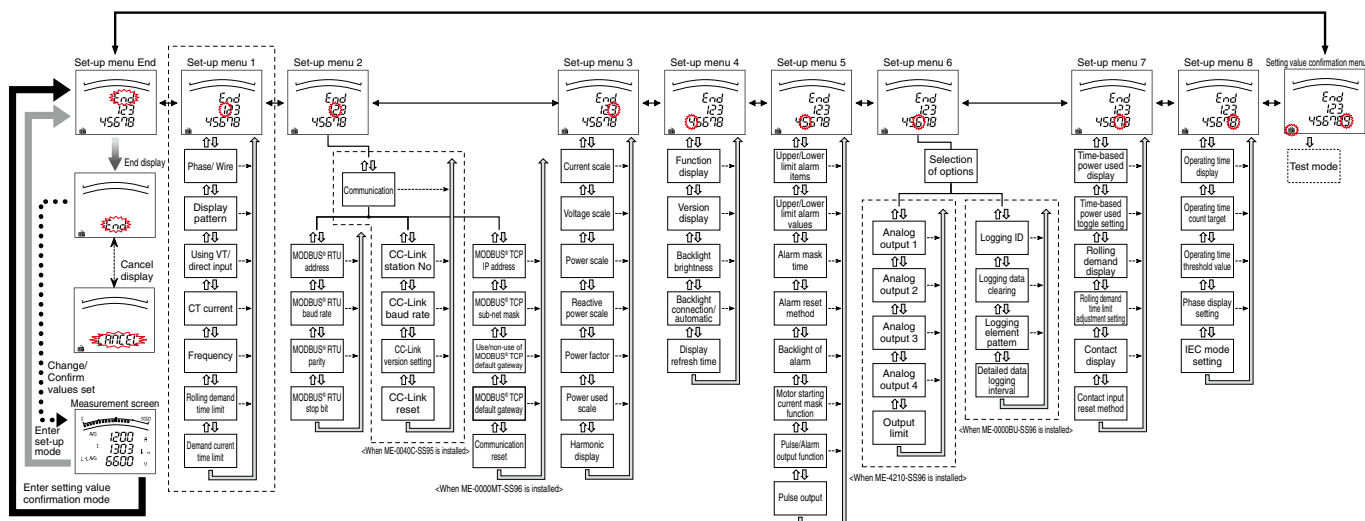

Notes 1. Basic measurements are possible by adjusting settings in menu 1 (dotted line area enclosed by dotted line).
 Notes 2. Item settings vary depending on the model.
 Notes 3. Setting confirmation menu 9 (test mode) is not displayed in the setting mode.

Symbol	Operation (function) details	Button operation
	Access set-up mode from operating mode	SET + RESET Simultaneously press for 2s
	Access setting value confirmation mode from operating mode	SET Press for 2s
	Save settings and return to operating mode	SET
	Select set-up menu	+ or -
	Move to next screen	SET
	Return to previous setting item	DISPLAY
	Skip remaining settings	SET Press for 1s
	Select cancel	+ or -

Operating Instructions

● Basic Set-up Operations

To access setting mode, press and hold the **(SET)** and **(RESET)** buttons down at the same time for 2s. Press the **(SET)** button to display the items to be set, and the **(+)** and **(-)** buttons to set the details. Settings can be saved for each set-up menu No. To do so, press the **(SET)** button when the End screen is displayed.

The underlined setting parameters are the initial value.

Set-up menu 1: Basic settings (set phase wire system, display pattern, Using VT/direct input, CT primary current, etc.)

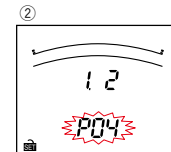
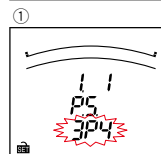
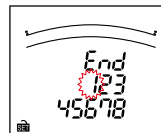
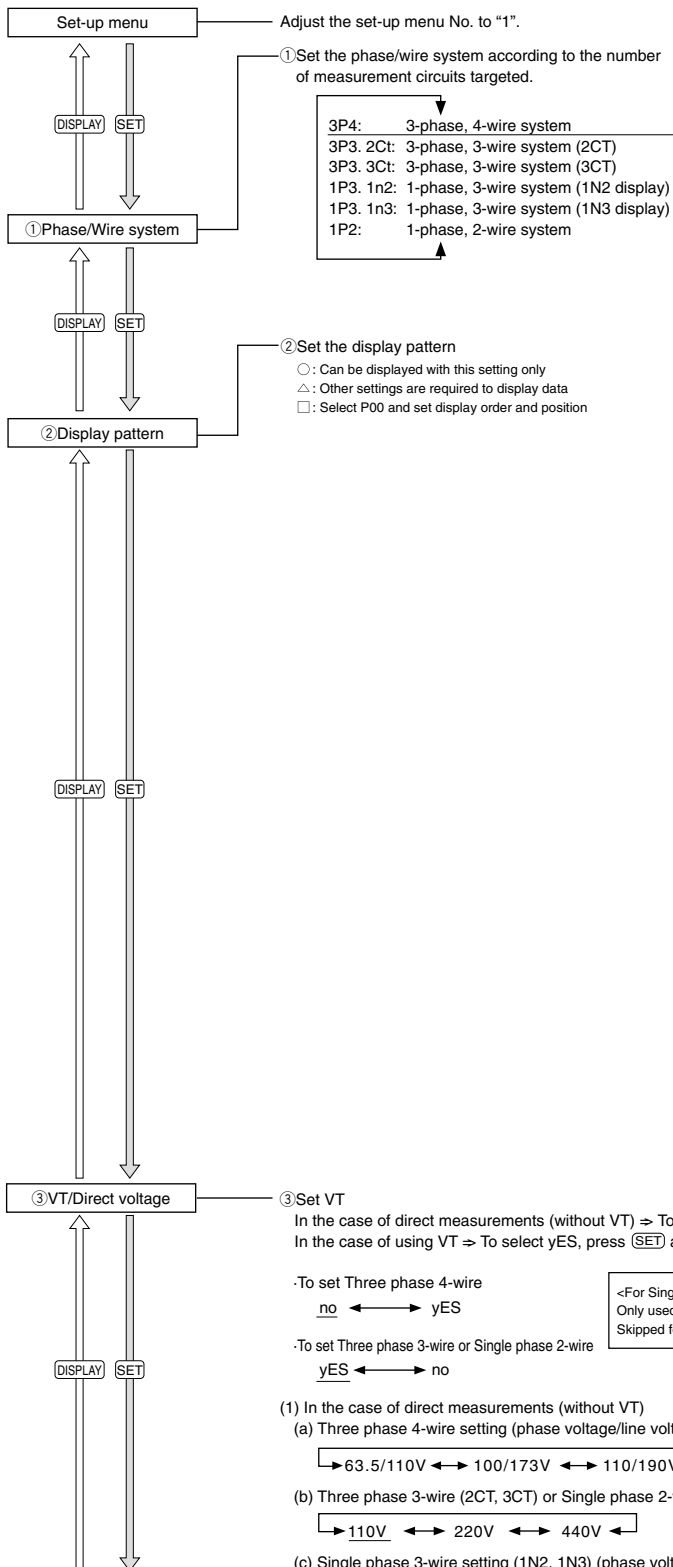

(1) ME96SSHA-MB / ME96SSRA-MB

Display pattern	Additional screens																			
	A	DA	V	W	PF	Var	VA	Hz	Wh (Imported)	Wh (Exported)	Varh (Imported leg)	Vah	Wh (Imported)	Wh (Exported)	varh (periodic)	DW	HIHV	DJ/DO	Operating time	
P01	○		○	○	○											△	△	△	△	△
P02	○		○	○	○				○				○	△		△	△	△	△	△
P03	○		○	○	○	○	○	○								△	△	△	△	△
P04	○		○	○	○	○	○	○					○	△	△					
P05			○													△	△	△	△	△
P06	○		○	○												△	△	△	△	△
P07	○		○	○												△	△	△	△	△
P08	○		○	○					○				○	△		△	△	△	△	△
P09	○	○	○													△	△	△	△	△
P10	○	○	○													△	△	△	△	△
P11	○	○	○						○				○	△		△	△	△	△	△
P12	○	○	○						○				○	△		△	△	△	△	△
P13	○	○	○	○	○	○	○	○				○	○	△	△	△	△	△	△	△
P00	□	□	□	□	□	□	□	□	□	□	□	□	□	□	□	△	△	△	△	△

(2) ME96SSEA-MB

Display pattern	Additional screens						
	A	DA	V	W	PF	Hz	Operating time
P01	○		○	○	○		△
P02	○		○	○	○	○	△
P03	○		○	○			△
P04	○		○	○			△
P05	○		○			○	△
P06	○	○	○				△
P07	○	○	○				△
P08	○	○	○			○	△
P09	○	○	○			○	△
P10	○	○	○			○	△
P11	○	○	○			○	△
P12	○	○	○			○	△
P13	○	○	○	○	○	○	△
P00	□	□	□	□	□	□	△

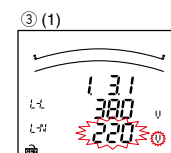
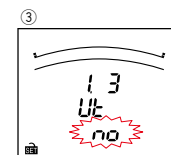



③ VT/Direct voltage

(2) In the case of using with VT

<Secondary voltage settings>

(a) Three phase 4-wire setting (phase voltage)

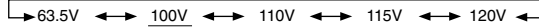

(b) Three phase 3-wire (2CT, 3CT) or Single phase 2-wire setting (line voltage)

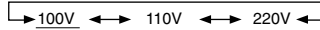

<Set primary voltage>

Can be set in 60~750,000V range (setting unit: V)

Under 100V: Top two digits settings Factory default settings

Over 100V: Top three digits settings Three phase 4-wire: 200V (phase voltage)

Three phase 3-wire; Single phase 2-wire: 10,000V (line voltage)

DISPLAY SET

DISPLAY SET

DISPLAY SET

DISPLAY SET

SET

④ CT current

④ Set CT.

Set the primary and secondary currents of the CT to be combined.

<Set secondary current>



<Set primary current>

Can be set in 1.0~30,000.0A range (setting unit: A)

Under 10A: Top two digits settings Factory default setting: 5.0A

Over 10A: Top three digits settings

⑤ Frequency

⑤ Set frequency.

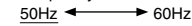

Notes1. Frequency scale on bar graph display will also change.

Notes2. Analog output scale will also change.

⑥ Rolling demand time limit

⑥ Set the rolling demand interval time limit (Only ME96SSHA-MB and ME96SSRA-MB).

(1) Interval time limit

Setting range	Setting interval
1 ~ 15 ~ 60 (min)	1min

(2) Sub-interval time limit

Setting range	Setting interval
1 ~ 60 (min)	1min

⑦ Demand current time limit

⑦ Set the demand current time limit.

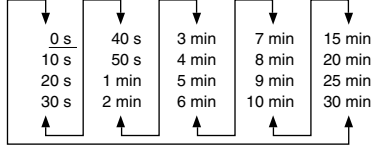

Set-up menu

Select another set-up menu or finish set-up.

■ To continue to set-up
Select the menu No.
using the (+) or (-) button.

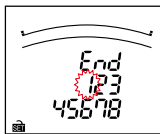

■ To finish set-up
Press the (+) or (-) button
to display the End screen,
then press the (SET) button
to save the settings.

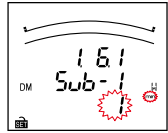
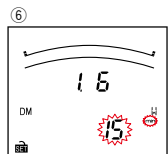
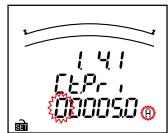
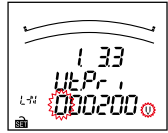
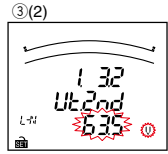
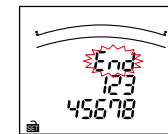

Set-up menu 2: MODBUS® RTU Communication settings

(when ME4210-SS96, ME0052-SS96 or ME0000BU-SS96 is installed and any options are not installed)

* Only in the case of ME96SSHA-MB or ME96SSRA-MB, it is applicable.

Set-up menu

Adjust the set-up menu No. to "2".

DISPLAY SET

DISPLAY SET

DISPLAY SET

① MODBUS® RTU communication address

① Set MODBUS® RTU communication address

Possible address settings: 1~255



② MODBUS® RTU communication address

② Set the MODBUS® RTU communication baud rate.

- 2400bps
- 4800bps
- 9600bps
- 19.2kbps
- 38.4kbps

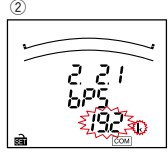
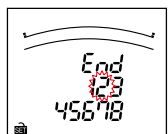
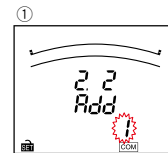

Operating Instructions

<Continued from previous page>

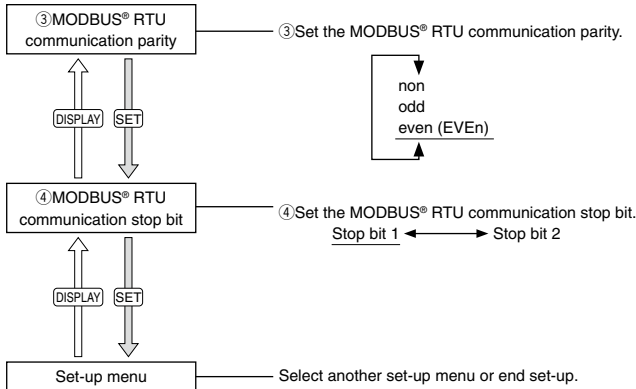

■ To continue to set-up
 Select the menu No. using the (+) or (-) button.

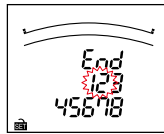

■ To finish set-up
 Press the (+) or (-) button to display the End screen, then press the (SET) button to save settings.

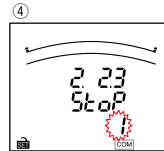
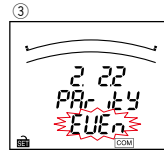
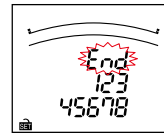

Set-up menu 2: CC-Link Communication settings (when ME-0040C-SS96 is installed)

* Only in the case of ME96SSHA-MB or ME96SSRA-MB, it is applicable.

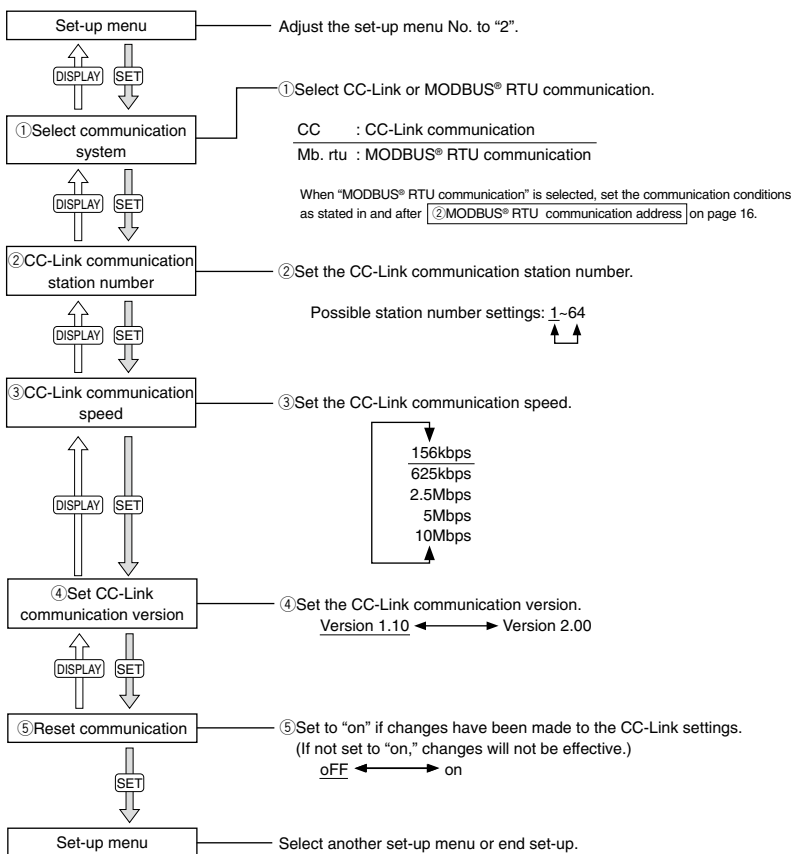

■ To continue to set-up
 Select the menu No. using the (+) or (-) button.

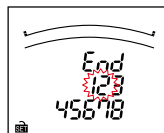

■ To finish set-up
 Press the (+) or (-) button to display the End screen, then press the (SET) button to save settings.

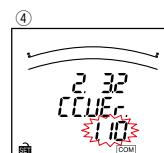
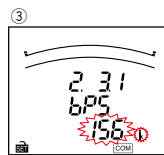
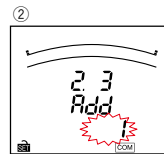

Set-up menu 2: MODBUS[®] TCP Communication settings (when ME-0000MT-SS96 is installed)

* Only in the case of ME96SSHA-MB or ME96SSRA-MB, it is applicable.

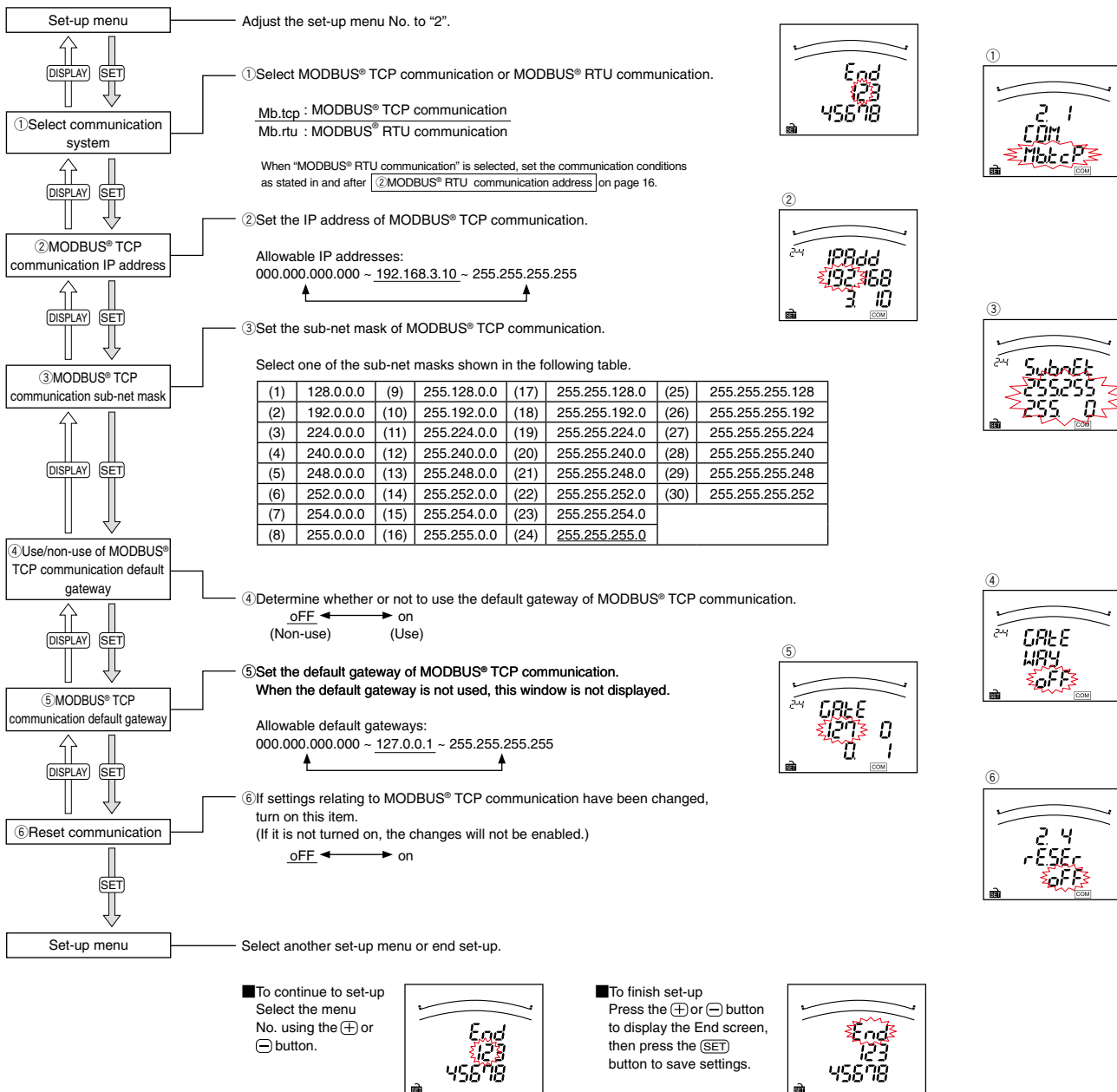

Operating Instructions

Set-up menu 3: Display settings (max. scale, active energy, harmonics, etc.)

Set-up menu

Adjust the set-up menu No. to "3".

↑

DISPLAY

↓

↑

SET

↓

① Current scale

① Set the maximum current scale value on the bar graph.

(1) Maximum current scale value

CT primary current value

←

SP.

→

(special primary current value)

Set-up menu 1.4.1 primary current setting

Set value

↑

DISPLAY

↓

↑

SET

↓

② Voltage scale

② Set the maximum voltage scale value on the bar graph

Maximum scale value.

+ 10 steps (approx. 250%)

± 0 steps (100%: instrument rating)

- 18 steps (approx. 20%)

↑

DISPLAY

↓

↑

SET

↓

③ Power scale

③ Set the maximum power/rolling demand scale value on the bar graph, and select positive-only scale or positive/negative scale (The rolling demand must be set only for ME96SSHA-MB and ME96SSRA-MB).

(1) Maximum scale value

+ 3 steps (approx. 120%)

± 0 steps (100%: instrument rating)

- 18 steps (approx. 20%)

(2) Positive-only or Positive/Negative

Positive-only

←

→

Positive/Negative

↑

DISPLAY

↓

↑

SET

↓

④ Reactive power scale

④ Set the maximum reactive power scale value on the bar graph (ME96SSHA-MB, ME96SSRA-MB only).

The setting procedure is the same as that described in ③ Power unit (1) Max. scale value.

The reactive power scale can only be positive/negative.

↑

DISPLAY

↓

↑

SET

↓

⑤ Power factor scale

⑤ Set the power factor scale on the bar graph.

-0.5 ~ 1 ~ 0.5 ← → 0 ~ 1 ~ 0

↑

DISPLAY

↓

↑

SET

↓

⑥ Measure power consumption

⑥ Set display combinations of receiving/transmitting, lag/lead, power used/reactive power used and the measurement method for reactive power used (ME96SSHA-MB, ME96SSRA-MB only).

Combinations (set value)	Display combinations						Reactive energy used measurement method
	Wh		varh				
	Imported	Exported	Imported	Exported	Lag	Lead	
I	○		○	○			2 Quadrants Measurement
II	○		○		○		
III	○	○	○			○	4 Quadrants Measurement
IV	○	○	○	○		○	

Combinations I, II ⇒ Suitable for measuring reactive power in facilities not equipped with in-house generators, and generally for capacitor loads where the power factor is close to zero.

Combinations III, IV ⇒ Suitable for measurements in facilities equipped with in-house generators.

<Example display screens>

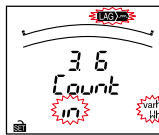

Combination I

in : Imported

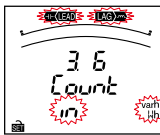

Combination II

out : Exported

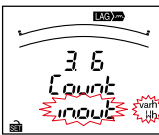

Combination III

in(LEAD) : varh lead

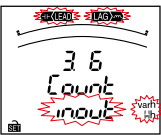

Combination IV

in(LAG) : varh lag

↑

DISPLAY

↓

↑

SET

↓

↑

DISPLAY

↓

↑

SET

↓

↑

DISPLAY

↓

↑

SET

↓

↑

DISPLAY

↓

↑

SET

↓

↑

DISPLAY

↓

↑

SET

↓

↑

DISPLAY

↓

↑

SET

↓

↑

DISPLAY

↓

↑

SET

↓

↑

DISPLAY

↓

↑

SET

↓

↑

DISPLAY

↓

↑

SET

↓

↑

DISPLAY

↓

↑

SET

↓

↑

DISPLAY

↓

↑

SET

↓

↑

DISPLAY

↓

↑

SET

↓

↑

DISPLAY

↓

↑

SET

↓

↑

DISPLAY

↓

↑

SET

↓

↑

DISPLAY

↓

↑

SET

↓

↑

DISPLAY

↓

↑

SET

↓

↑

DISPLAY

↓

↑

SET

↓

↑

DISPLAY

↓

↑

SET

↓

↑

DISPLAY

↓

↑

SET

↓

↑

DISPLAY

↓

↑

SET

↓

↑

DISPLAY

↓

↑

SET

↓

↑

DISPLAY

↓

↑

SET

↓

↑

DISPLAY

↓

↑

SET

↓

↑

DISPLAY

↓

↑

SET

↓

↑

DISPLAY

↓

↑

SET

↓

↑

DISPLAY

↓

↑

SET

↓

↑

DISPLAY

↓

↑

SET

↓

↑

DISPLAY

↓

↑

SET

↓

↑

DISPLAY

↓

↑

SET

↓

↑

DISPLAY

↓

↑

SET

↓

↑

DISPLAY

↓

↑

SET

↓

↑

DISPLAY

↓

↑

SET

↓

↑

DISPLAY

↓

↑

SET

↓

↑

DISPLAY

↓

↑

SET

↓

↑

DISPLAY

↓

↑

SET

↓

↑

DISPLAY

↓

↑

SET

↓

↑

DISPLAY

↓

↑

SET

↓

↑

DISPLAY

↓

↑

SET

↓

↑

DISPLAY

↓

↑

SET

↓

↑

DISPLAY

↓

↑

SET

↓

↑

DISPLAY

↓

↑

SET

↓

↑

DISPLAY

↓

↑

SET

↓

↑

DISPLAY

↓

↑

SET

↓

↑

DISPLAY

↓

↑

SET

↓

↑

DISPLAY

↓

↑

SET

↓

↑

DISPLAY

↓

↑

SET

↓

↑

DISPLAY

↓

↑

SET

↓

↑

DISPLAY

↓

↑

SET

↓

↑

DISPLAY

↓

↑

SET

↓

↑

DISPLAY

↓

↑

SET

↓

↑

DISPLAY

↓

↑

SET

↓

↑

DISPLAY

↓

↑

SET

↓

↑

DISPLAY

↓

↑

SET

↓

↑

DISPLAY

↓

↑

SET

↓

↑

DISPLAY

↓

↑

SET

↓

↑

DISPLAY

↓

↑

SET

↓

↑

DISPLAY

↓

↑

SET

↓

↑

DISPLAY

↓

↑

SET

↓

↑

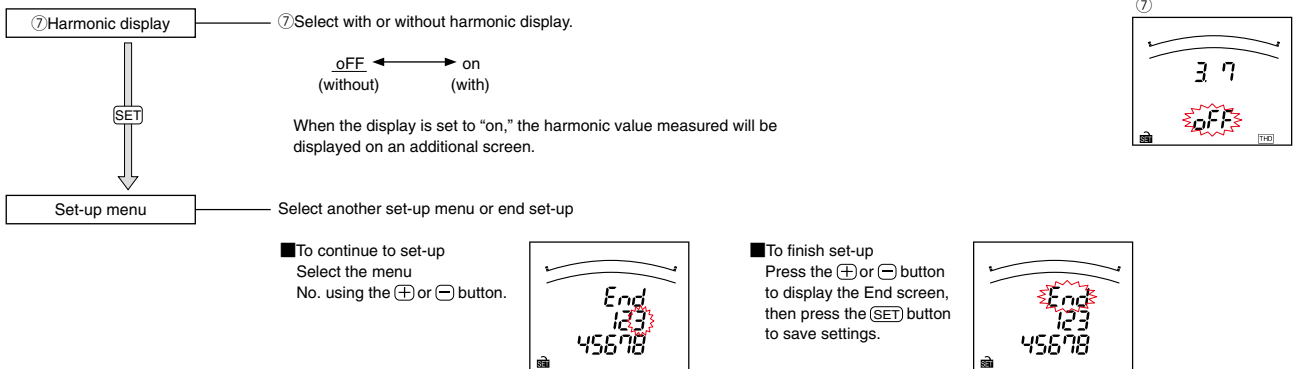

Set-up menu 6: Analog output setting (only when ME-4210-SS96 is installed)

* Only in the case of ME96SSHA-MB or ME96SSRA-MB, it is applicable.

This menu will not appear if ME-4210-SS96 (optional) is not installed.

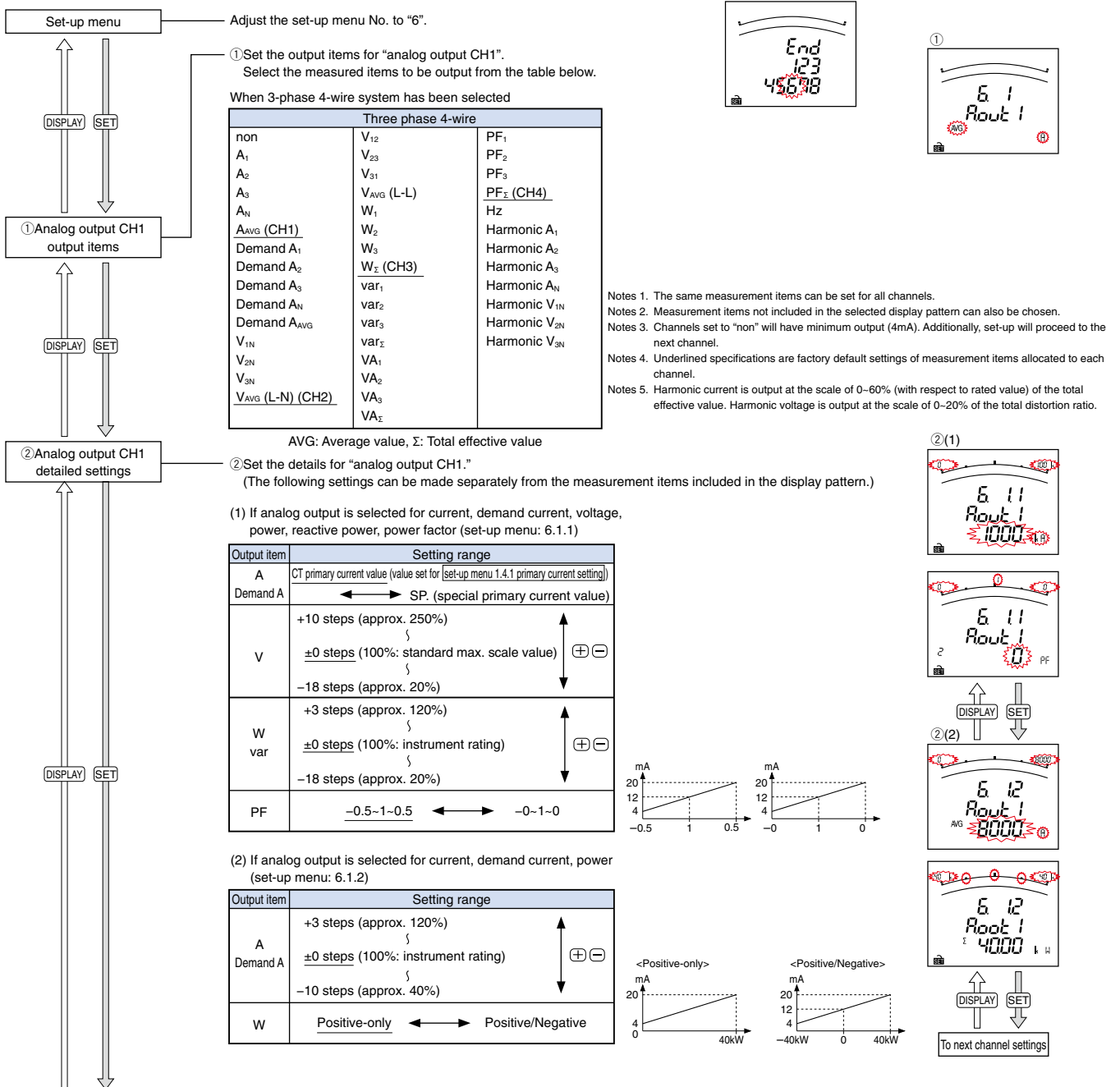

Operating Instructions

<Continued from previous page>

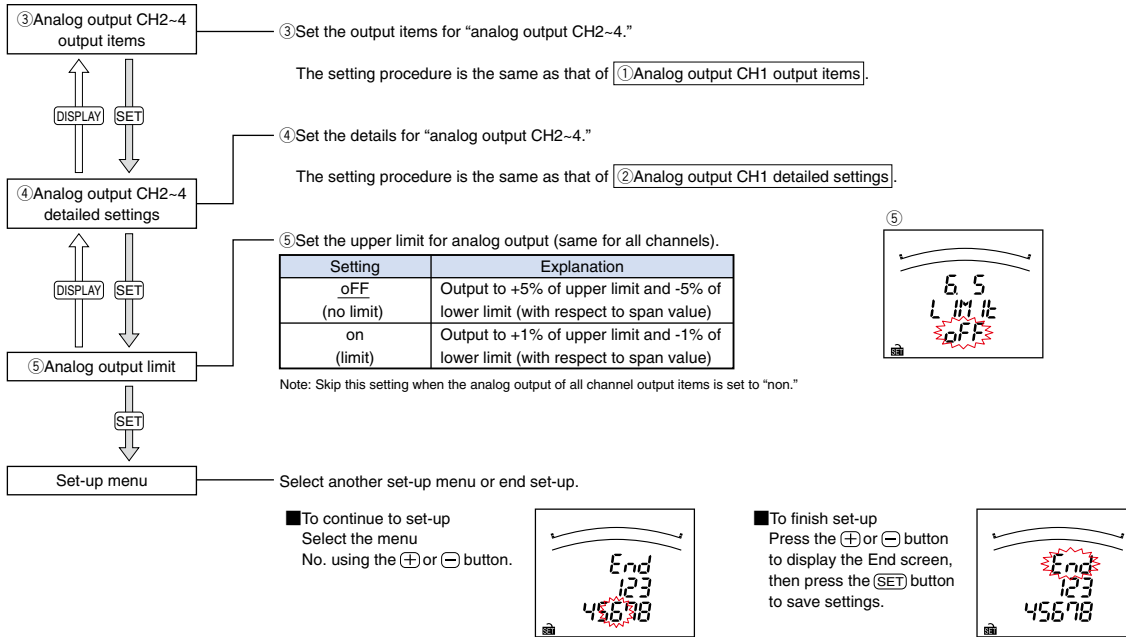

Set-up menu 6: Logging setting (only when ME-0000BU-SS96 is installed)

*Only in the case of ME96SSHA-MB or ME96SSRA-MB, it is applicable.

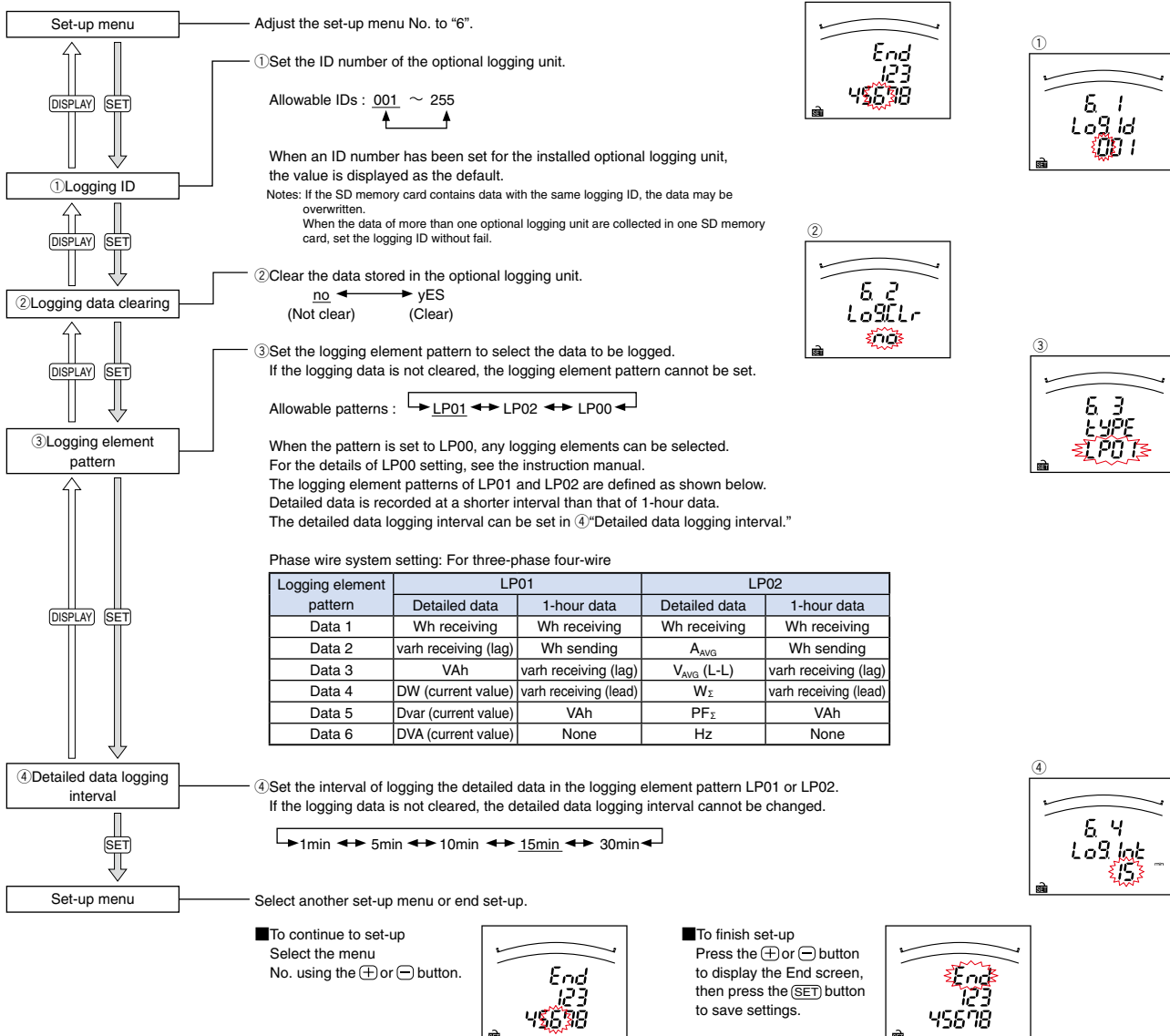

Operation (for ME96SSHA-MB)

● Display Change

Press **[DISPLAY]**, the measurement display switches over.
When the **[DISPLAY]** and **[+/-]** buttons are held down for 2 seconds or more, the display will change in reverse order.

Example of changing display (Three phase 4-wire system; display pattern: P01; no additional screens)

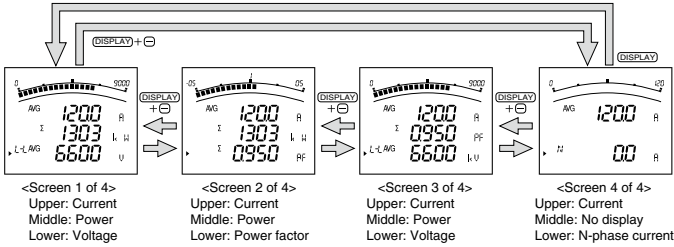

● Bar Graph Display

Items measured can be displayed on the bar graph. By displaying one item by a bar graph and other three items by digital numbers four elements can be displayed at once.

● Bar graph explanation

The **[▶]** or **[↑]** mark indicates that the measurement item is displayed on the bar graph.

● Select bar graph

Press the **[+]** or **[-]** button to select the measurement items to be displayed on the bar graph.

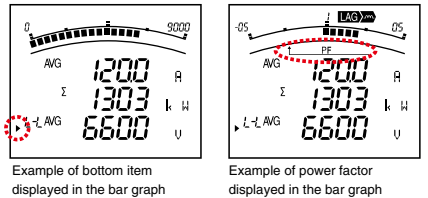
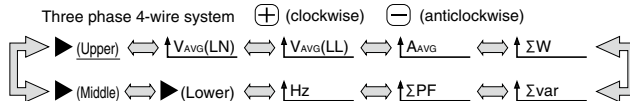

● Maximum/Minimum Display Values

Press the **[MAX/MIN]** button to change to the maximum and minimum values of the display screen. Press it again to return to the current value display screen.

● Reset Maximum/Minimum Values

Press the **[RESET]** button for 2s to reset the maximum/minimum values of the measurement items displayed. The maximum/minimum values will become the current values.

Press the **[RESET]** and **[+]** buttons simultaneously for 2s to reset all maximum/minimum values. The maximum/minimum values will become the current values.

Example of switching between changing current value display and maximum/minimum value display screens

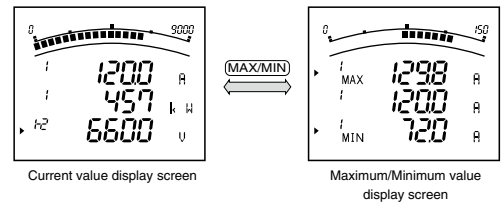

● Displaying Active energy/Reactive energy/Apparent energy

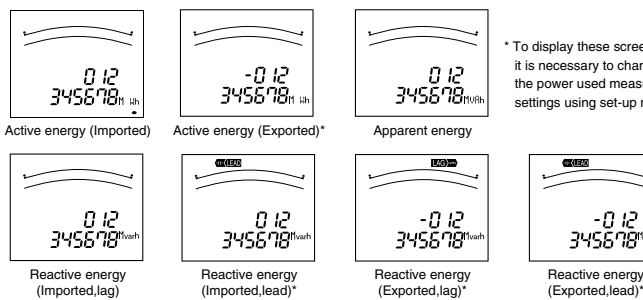

Change the unit (M, k, none) or increase the digits in the bottom display for power used/reactive power used/apparent power used/time-based power used to check the lower/higher-order digits. Push the **[+]** and **[-]** buttons simultaneously for 2s to switch between screens.

Power used (receiving): Example of changing 012.345.678.901.234.567Wh

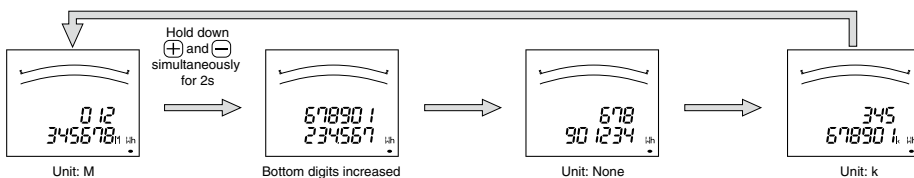

● Reset Active energy/Reactive energy/Apparent energy

Press the **[SET]**, **[RESET]** and **[PHASE]** buttons simultaneously for 2s to reset all of the following together: active energy/reactive energy/apparent energy (this operation only works on the current value display screen).

Operating Instructions

● Changing Upper/Lower Limits for Alarm Activation and Cancellation

When measurement values exceed the upper/lower limit values that have been set, an alarm activates and the screen begins to blink. The blinking ▲ mark on the bar graph indicates the current upper/lower limit value settings.

● During Alarm Generation

Alarm condition: When a measured value exceeds the alarm value setting, the screen begins to flash and the alarm contact closes.
Alarm cancelled: When the alarm is cancelled, the screen stops flashing and the alarm contact opens.

Alarm reset method		Measurement value ≥ Upper limit alarm value (or ≤ Lower limit alarm value)	Measurement value < Upper limit alarm value (or > Lower limit alarm value)
Automatic (Auto)	Screen	ALARM [HI] or [LO] will flash 	Constantly on Upper/Lower limit indicator
	Alarm contact	Closed	Open
Manual (Hold)	Screen	ALARM [HI] or [LO] will flash (Alarm activated)	ALARM [HI] or [LO] will flash (Alarm on hold) → RESET → (Alarm cancelled)
	Alarm contact	Closed	Closed → Open

If the item that caused the alarm is displayed on the screen, the digital value, unit (A, V, W, var, PF, HZ, %, DM, THD) and phase (1, 2, 3, N) will be displayed as shown in the table below. If the item is not displayed on the screen, the screen will not flash.

Alarm status	Digital value	Unit	Phase
Alarm activated	Flashing	Flashing	Flashing
Alarm on hold	On	Flashing	Flashing
Alarm cancelled	On	On	On

* Only flashes if the phase that caused the alarm is being displayed.

● Alarm Cancel

The alarm can be reset automatically or manually. The alarm recovery method varies according to the reset method setting.

Alarm reset method	Cancellation method
Automatic (Auto)	The alarm resets automatically when the measurement value returns to within the upper/lower limit set value.
Manual (Hold)	The alarm setting changes to "on hold" even after the measurement value becomes returns to within the upper/lower limit value setting. Once the value returns to within the upper/lower limit value set, perform the following alarm recovery operations. (Note: Alarm recovery operations cannot be carried out from the maximum/minimum value display screen or contact input screen.) <To select item and cancel alarm> When the item that caused the alarm is displayed, press the (RESET) button to deactivate the alarm. (For items with phases such as current and voltage, it is necessary to) press the (RESET) button for each phase to cancel the alarm. <To cancel alarms for all items> To cancel alarms for all items at once (batch), press the (RESET) button for 2s when in operating mode.

● Alarm delay Time

If an alarm delay time has been set, alarm notification begins only when the measurement value exceeds the upper/lower limit alarm value for a period longer than the alarm delay time.

● Harmonic Display

The harmonic effective value, distortion ratio and content ratio can be displayed. To do so, first set the harmonic display (set-up menu: 3.7).

<Example of total harmonic current display>

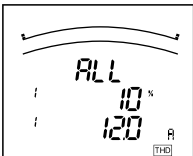

<Example of 5th-degree harmonic voltage display>

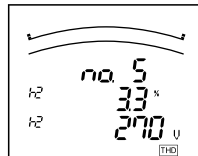

Upper: Degree No.
Middle: Distortion (content) ratio
Lower: Effective value

Degree	Harmonic current		N-phase harmonic current		Harmonic voltage	
	RMS	Distortion (content) ratio	RMS	Distortion (content) ratio	RMS	Distortion (content) ratio
Harmonic total	○	○	○	—	○	○
1st (fundamental)	○	—	○	—	○	—
3rd, 5th, 7th, 9th, 11th, 13th, 15th, 17th, 19th, 21st, 23rd, 25th, 27th, 29th and 31st	○	○	○	—	○	○

● Changing the Harmonic Degree Display

Press the (+) or (-) button to change the harmonic degree.

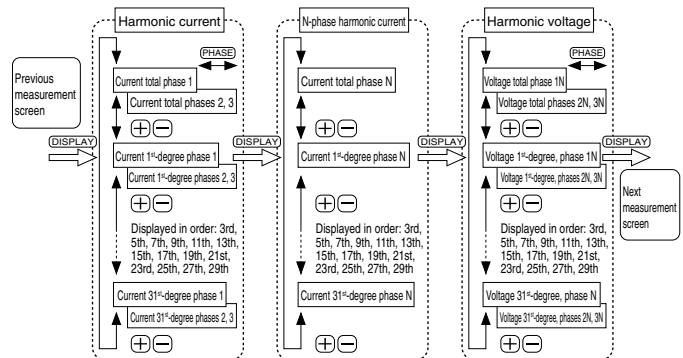



● ME96SSEA-MB Screen Display (Three phase 4-wire)

Display pattern (digital display)	Screen set based on display pattern							Additional screens (set in set-up menu Nos.3 and 8)					
	No.1	No.2	No.3	No.4	No.5	No.6	No.7	No.8	No.9	No.10	No.11	No.12	No.13
P01	Upper	A	A	A	A				Total	Total	Total	—	—
	Middle	W	W	PF	—				Total distortion ratio	—	Distortion (content) ratio	hour1	hour2
	Lower	V	PF	V	AN				Total RMS	Total RMS	Total RMS	Operating time	Operating time
P02	Upper	A	A	A	A	A		—	Same as above	Same as above	Same as above	Same as above	Same as above
	Middle	V	W	PF	—	Hz		Wh					
	Lower	Wh	Wh	Wh	AN	Wh							
P03	Upper	A1	V1N	A	A				Same as above	Same as above	Same as above	Same as above	Same as above
	Middle	A2	V2N	—	—								
	Lower	A3	V3N	V	AN								
P04	Upper	A	A1	V1N	A				Same as above	Same as above	Same as above	Same as above	Same as above
	Middle	V	A2	V2N	—								
	Lower	W	A3	V3N	AN								
P05	Upper	A	A	A1	V1N	A		—	Same as above	Same as above	Same as above	Same as above	Same as above
	Middle	V	W	A2	V2N	—		Wh					
	Lower	Wh	Wh	A3	V3N	AN							
P06	Upper	A	A1	DA1	V1N	A	DA		Same as above	Same as above	Same as above	Same as above	Same as above
	Middle	DA	A2	DA2	V2N	—	—						
	Lower	V	A3	DA3	V3N	AN	DAN						
P07	Upper	A	A	A1	DA1	V1N	A	DA	Same as above	Same as above	Same as above	Same as above	Same as above
	Middle	DA	DA	A2	DA2	V2N	—	—					
	Lower	V	W	A3	DA3	V3N	AN	DAN					
P08	Upper	A	A	DA1	V1N	A	DA	—	Same as above	Same as above	Same as above	Same as above	Same as above
	Middle	DA	V	DA2	V2N	—	—	Wh					
	Lower	Wh	Wh	DA3	V3N	AN	DAN						
P09	Upper	A	A	A	DA	W	A	DA	—	Same as above	Same as above	Same as above	Same as above
	Middle	DA	W	V	V	—	—	Wh					
	Lower	Wh	Wh	Wh	Wh	Wh	AN	DAN					
P00	Upper	Free	Free	Free	Free			—	Same as above	Same as above	Same as above	Same as above	Same as above
	Middle	Free	Free	Free	Free			Wh					
	Lower	Free	Free	Free	Free								

● ME96SSEA-MB Screen Display (Three phase 3-wire, Single phase 3-wire, Single phase 2-wire)

Display pattern	Screen set based on display pattern					Additional screens (set in set-up menu Nos.3 and 8)				
	No.1	No.2	No.3	No.4	No.5	No.6	No.7	No.8	No.9	No.10
P01	Upper	A	A	A						
	Middle	W	W	PF			Total distortion ratio	Total distortion ratio	hour1	hour2
	Lower	V	PF	V			Total RMS	Total RMS	Operating time	Operating time
P02	Upper	A	A	A	A		—	Same as above	Same as above	Same as above
	Middle	V	W	PF	Hz		Wh			
	Lower	Wh	Wh	Wh	Wh					
P03	Upper	A1	V12	A				Same as above	Same as above	Same as above
	Middle	A2	V23	—						
	Lower	A3	V31	V						
P04	Upper	A	A1	V12				Same as above	Same as above	Same as above
	Middle	V	A2	V23						
	Lower	W	A3	V31						
P05	Upper	A	A	A1	V12		—	Same as above	Same as above	Same as above
	Middle	V	W	A2	V23		Wh			
	Lower	Wh	Wh	A3	V31					
P06	Upper	A	A1	DA1	V12		—	Same as above	Same as above	Same as above
	Middle	DA	A2	DA2	V23		Wh			
	Lower	V	A3	DA3	V31					
P07	Upper	A	A	A1	DA1	V12		—	Same as above	Same as above
	Middle	DA	DA	A2	DA2	V23	Wh			
	Lower	V	W	A3	DA3	V31				
P08	Upper	A	A	DA1	V12		—	Same as above	Same as above	Same as above
	Middle	DA	V	DA2	V23		Wh			
	Lower	Wh	Wh	DA3	V31					
P09	Upper	A	A	A	DA	W		—	Same as above	Same as above
	Middle	DA	W	V	V	—	Wh			
	Lower	Wh	Wh	Wh	Wh	Wh				
P00	Upper	Free	Free	Free	Free		—	Same as above	Same as above	Same as above
	Middle	Free	Free	Free	Free		Wh			
	Lower	Free	Free	Free	Free					

● Phase/Wire Displays

The phase/wire system will be displayed as shown in the following table and is common for all models.

Phase/Wire settings		1P2W	1P3W(1N2)	1P3W(1N3)	3P3W
Top phase display	1	None	1	1	1
	2	None	N	N	2
	3	None	2	3	3
Voltage	12	None	1N	1N	12
	23	None	2N	3N	23
	31	None	12	13	31

External Dimensions/Installation/Connections

Dimensions

ME96SSHA-MB, ME96SSRA-MB

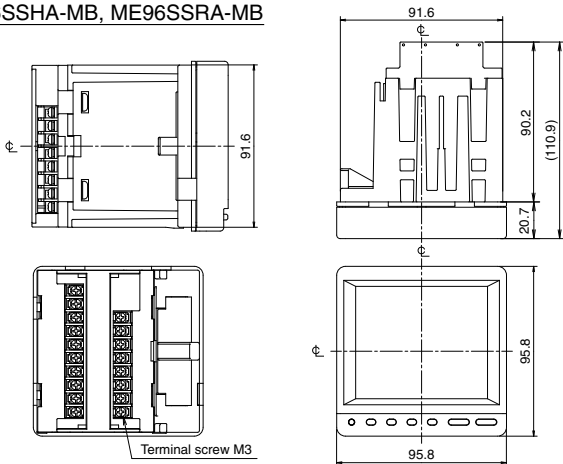

ME96SSEA-MB

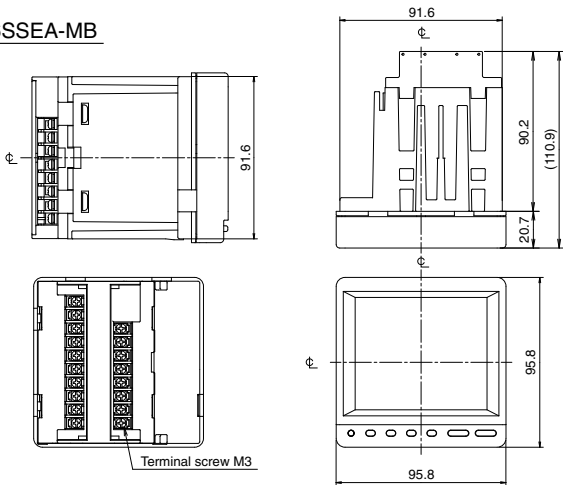

Optional Plug-in Module : ME-4210-SS96, ME-0040C-SS96, ME-0052-SS96

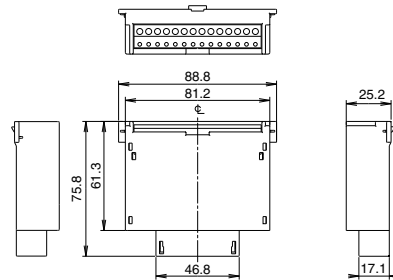

Optional Plug-in Module : ME-0000BU-SS96

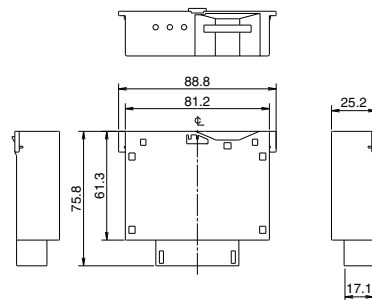

Optional Plug-in Module : ME-0000MT-SS96

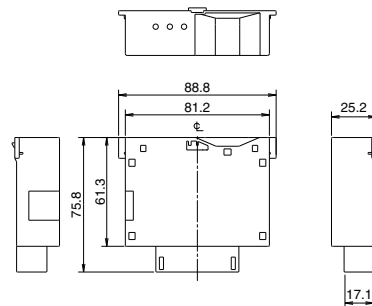

Mounting

1 Dimension of panel

Panel hole dimensions are as shown in the following figure. It can be attached to a panel with thickness of 1.6 to 4.0mm.

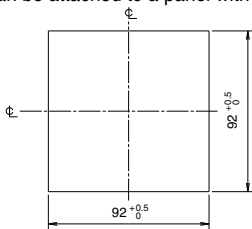

2 View Angle

The contrast of the display changes at view angle. Mount it at the position that is easy to see.

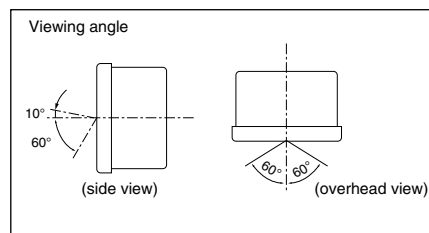

3 Attachment

For attachment of the basic device into the panel hole, attach according to the following procedure.

- ① The attachment lug is installed in two holes of the top and bottom of the basic device.
- ② Tighten the screws of the lug, and fix onto the panel.

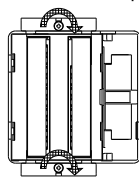
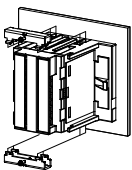

Note

To prevent damage to the panel and screws, do not fasten screws too tightly.
Recommended torque for these products: 0.3~0.5N·m (approx. half of standard torque)
Also, please tighten the upper and lower screws at the same time.

Main unit mounting screws: M3

4 Installing Optional Plug-in Module

When installing the optional plug-in module onto the basic device, install according to the following procedure.

- ① Remove the optional cover.
- ② Attach the optional unit to the main unit.

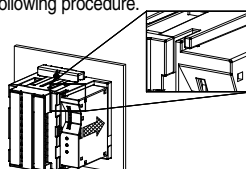
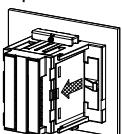

Fit the protruding part of the optional unit into the slot in the main unit.

Wiring

1 Applicable Cable Size

The table on the right describes the applicable wire size.

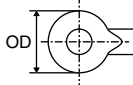
Part	Screw type	Wire specifications	Tightening torque
Product main body (auxiliary power supply, voltage input, current input and MODBUS [®] RTU communication terminals)	M3	<ul style="list-style-type: none"> Use of crimp-style terminals: AWG26 to 14 (2 wires can be connected.) Applicable crimp-style terminal: OD of 6 mm or less, for screw M3 	0.6 to 0.8 N·m
Optional unit terminal (ME-0052-SS96, ME-0040C-SS96, ME-4210-SS96)	Screwless	<ul style="list-style-type: none"> Single wire and stranded wire: AWG24 to 14 (Rod terminal can be used together with stranded wire.) Wire stripping length: 10 to 11 mm *1: To conform to UL Standard, use in accordance with the following requirements. <ul style="list-style-type: none"> Single wire and stranded wire: AWG24 to 18 Use of a bar terminal is not allowed. *2: When using a bar terminal for inserting two wires, select a terminal whose insertion part into the terminal block is 12 to 13 mm long. 	—

2 Wiring

Optional Plug-in Module Terminal

- Remove the wire casing at the end of the wire and solder to the rod terminal.
- With the lever pushed in, insert the wire and then release the lever to connect.

Optional Plug-in Module Terminal

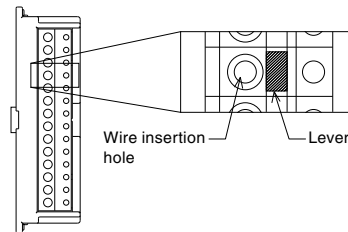

3 Confirmations

After wiring, make sure the following:

- All wiring is connected
- There is no mistake in wiring

Note

Protective sheet

There is a protective sheet covering the LCD screen to prevent scratching during panel installation. Please remove the sheet before using the meter. When removing the sheet, the LCD may turn on due to the static electricity generated. This is not abnormal; the LCD will turn off after a short time.

Installation position

If installing the unit at the panel edge, choose an installation position where there is sufficient space for wiring work.

Optional unit

Turn the auxiliary power supply off before attaching the optional unit. If attached with the power on, the main unit will not recognize the optional unit. To remedy this, turn off/restart the auxiliary power supply or execute the "instrument restart" operation.

Wiring Diagrams

Three phase 4-wire system: Direct input

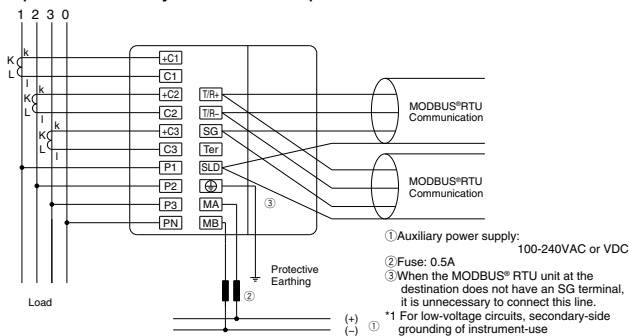

Three phase 4-wire system: With VT

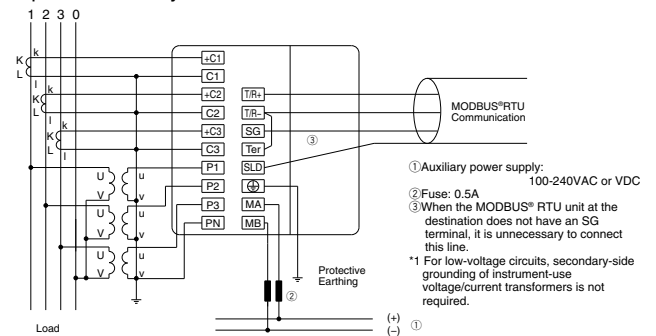

Three phase 3-wire system: Direct input, 2CT

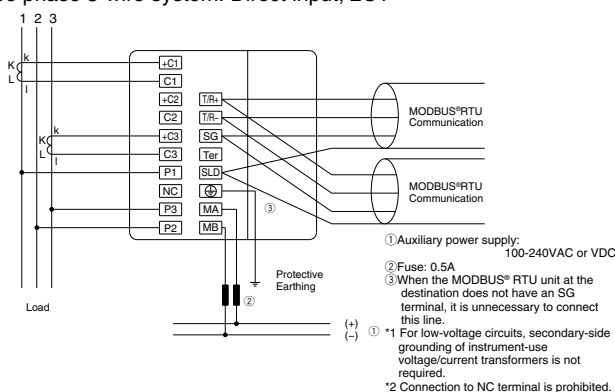

Three phase 3-wire system: With VT, 3CT

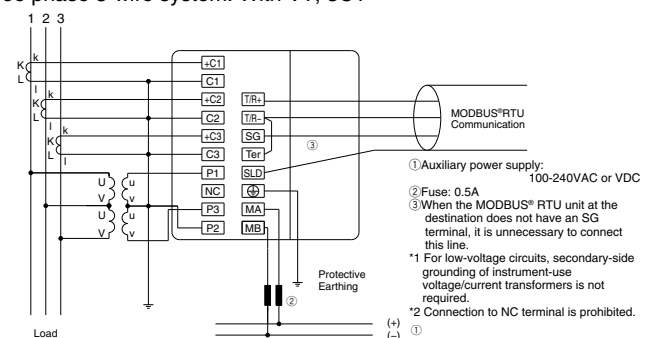

External Dimensions/Installation/Connections

Wiring Diagrams (Continued)

Single phase 3-wire system

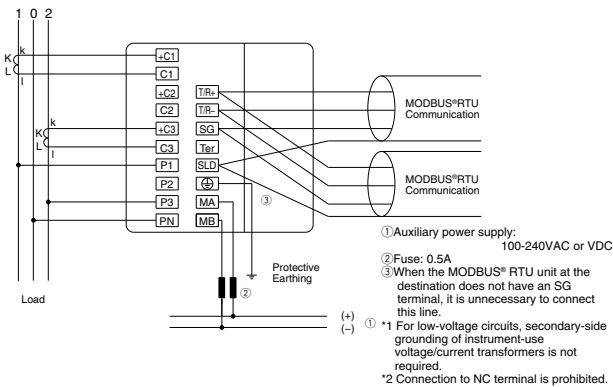

Single phase 2-wire system: With VT

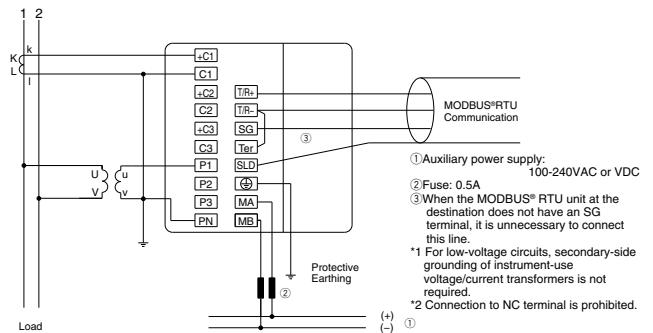

Note

1. The voltage input terminal will vary depending on if it is a 3-phase, 3-wire system or otherwise.
2. VT/CT polarity errors will cause incorrect measurement.
3. Always use the grounding terminal (⊕) in a grounded state. Perform grounding with a grounding resistance of 100Ω or less. Insufficient grounding may cause erroneous operation.
4. Use shielded twisted-pair cables for transmission signal lines.
5. Use terminal resistance (120Ω) for devices at both ends of the MODBUS® RTU communication transmission line. These meters can be terminated at 120Ω by short-circuiting the "T-" and "Ter" terminals.
6. Use the thickest possible grounding wire to ensure low impedance.
7. MODBUS® RTU transmission signal cables must not be in close proximity or bundled with high-voltage cables.

Optional Plug-in Module: ME-4210-SS96

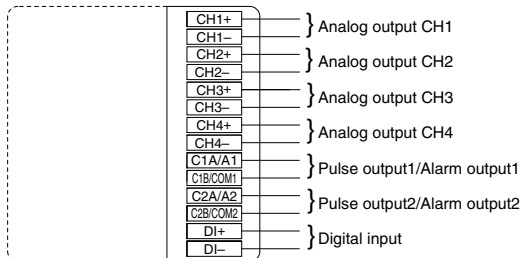

Optional Plug-in Module: ME-0040C-SS96

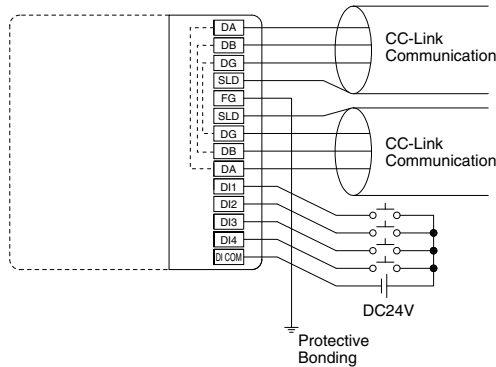

Optional Plug-in Module: ME-0052-SS96

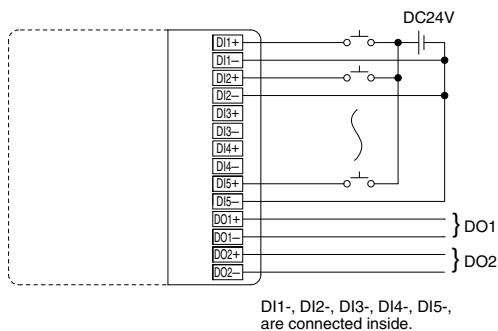

Optional Plug-in Module: ME-0000MT-SS96

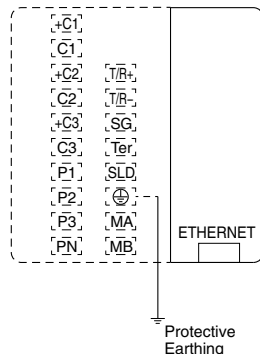

Optional Plug-in Module: ME-0000BU-SS96

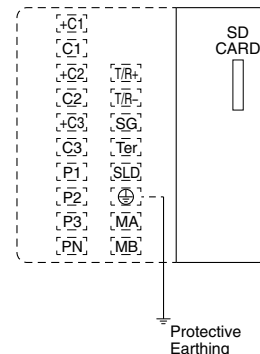

Wiring Diagrams (Continued)

Note

1. Pulse output, alarm output, and contact input/output cables must not be in close proximity or bundled with power cables or high-voltage cables. When laid parallel, separate by the distance shown in the following table.

Condition	Distance
Power lines under 600V/600A	More than 30cm
Other power lines	More than 60cm

2. Analog output cables must not be in close proximity or bundled with other power cables or input cables (e.g., VT, CT, auxiliary power supply). In addition, to prevent noise, surge and induction, use shielded cables or twisted-pair cables. Make sure that cables are as short as possible.
3. There is no insulation between the MODBUS® RTU communication portion and the optional module ME-4210-SS96, ME-0040C-SS96 or ME-0000MT-SS96.
4. Use only designated cables when connecting the CC-Link (see communication specifications). CC-Link dedicated cables cannot be used at the same time as CC-Link dedicated high-performance cables. Normal data transmission cannot be guaranteed if used at the same time.
The terminal resistance value varies depending on the type of dedicated cable.
5. For cables connecting the CC-Link, connect shielded cables to "SLD" and ground "FG" cables. "SLD" and "FG" cables are connected inside the unit.
6. CC-Link transmission lines are small signal circuits: separate from strong electrical circuits by a distance of 10cm or more, or 30cm or more if laid in parallel over a long distance.
Ground the terminal before use.
7. For CC-Link transmission, always use dedicated lines and comply with conditions for total wiring distance, distance between stations and terminal resistance values according to the communication speed. Not doing so may prevent normal communication (see the CC-Link Master Unit Operations Manual for information on dedicated lines and wiring conditions).
8. The terminal resistance supplied with the CC-Link Master Unit must always be used for the units at both ends of the CC-Link transmission line. If the meter is at the end of the CC-Link transmission line, connect it between the DA and DB terminals.
9. Communication errors may occur under the influence of high-frequency noise from other devices in the installation environment during high-speed communication (100 Mbps) via 100BASE-TX connection of MODBUS® TCP.
Measures to be taken when the network system is configured to avoid the influence of high-frequency noise are shown below.
 - (1) Wiring connection
 - When laying a twisted pair cable, do not bundle the cable together with any main circuit line or power line or lay it close to such a line.
 - Keep the twisted pair cables in the duct.
 - (2) Communication method
 - Increase the number of communication retries as needed.
 - Replace the hub to be used for connection with that for 10 Mbps, and communicate at a data transmission speed of 10 Mbps.
10. Do not connect any terminal or RJ45 connector in the live state.
11. Do not insert or remove the SD memory card in the live state.

Rated voltage for each phase/wire system

Phase/Wire	Connection	Rated voltage	Figure
Three phase 4-wire	Star	Max. 277VAC (L-N)/480VAC(L-L)	Figure 1
	Delta	Max. 220VAC (L-L)	Figure 2
Three phase 3-wire	Star	Max. 440VAC (L-L)	Figure 3
	-	Max. 220VAC (L-N)/440VAC(L-L)	Figure 4
Single phase 2-wire*	Delta	Max. 220VAC (L-L)	Figure 5
	Star	Max. 440VAC (L-L)	Figure 6

* The circuit derived from the three-phase 3-wire delta connection and the single-phase 2-wire transformer circuit have the maximum rating of 220 VAC. The circuits derived from the three-phase 4-wire and three-phase 3-wire star connections and single-phase 3-wire connection have the maximum rating of 440 VAC.

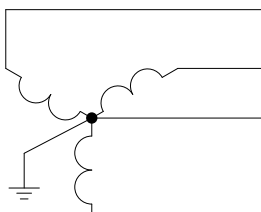

Fig. 1. Three phase 4-wire (star)

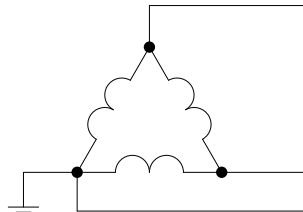

Fig. 2. Three phase 3-wire (delta)

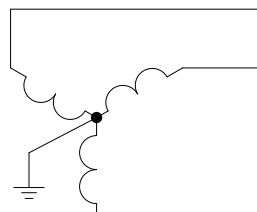

Fig. 3. Three phase 3-wire (star)

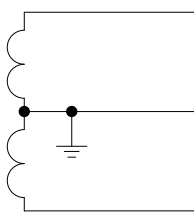

Fig. 4. Single phase 3-wire

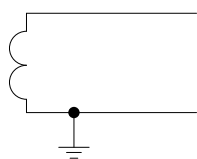

Fig. 5. Single phase 2-wire (delta)

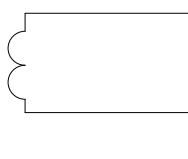

Fig. 6. Single phase 2-wire (star)

Related Products

■ EcoWebServerIII

Mitsubishi Electric Energy-saving Data Collection Server
From visualization to publication of energy data

Simple Set-up

When using the set-up software supplied, power management meters connected to CC-Link and measurement data can be set by mouse and keyboard operations.

Display Measurement Data as Graphs on a Web Browser

The main unit has a built-in web server that allows anyone, anywhere to understand the amount of energy being used in real time via computer without requiring additional software, thereby supporting early detection of energy waste.

Automatic Transmission of Data Collected, Mail Notifications and Contact Output

Users are notified of changes in energy, facilities, etc. via e-mail and alarms. Energy management targets and status monitoring of entire factories and buildings help ensure that problems onsite are detected without fail.

- ◇ PLC data can also be sent to EcoWebServerIII by Ethernet.
- ◇ Data of various sites can be browsed in the head office by utilizing the internal network.

Collection, storage, visualization, publication on the web, analysis and monitoring
All can be realized by one server.

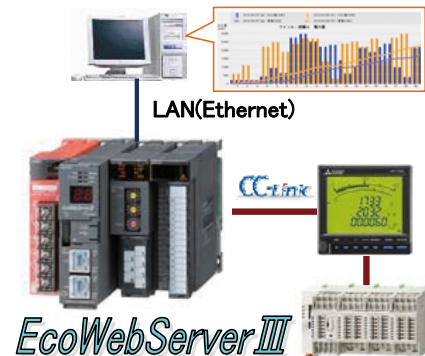

■ ME110SS

Mitsubishi Electronic Indicating Instrument Super-S Series
Highly functional and easy-to-use series supporting the realization of various instrument monitoring systems and energy-saving measurement monitoring systems

Common-use Models

Two phase wiring system (Three phase 3-wire and Three phase 4-wire systems) were required previously, but user needs can now be met with a single unit.

Enhanced Visibility

Wide-angle-view LCD with top and bottom tiers integrated for total freedom in installation. Crystal-clear display makes text even easier to read when viewed from the front.

A high-brightness backlight is provided, and its brightness can be adjusted in five stages.

Operating Time, CO₂ Conversion, Alarm Display Functions

Functions that enable load operating time measurement, conversion to CO₂ emissions and backlight blinking at the time of an alarm are incorporated.





■ EcoMonitorPlus

Energy measuring units helpful in adding units for increased number of measuring circuits and preventive maintenance by simultaneous measurement of electric power and leakage

Phased expansion of energy-saving system

At first, energy-saving measurement can be started on a small scale from a desired place.

The system can be configured by adding units according to the increase of measuring circuits.

Leakage current monitoring

Lineup of basic units for monitoring insulation

Helpful in early detection of equipment problems through accurate leakage current trend monitoring by Ior method

* Ior: Leakage current caused by insulation deterioration (leakage current of resistive component)

Simple management of measurement data with prepared forms and graphs

Data can be collected by the logging unit (SD memory card) without the host application on the PC, etc.

Forms and graphs can be easily prepared by using the spreadsheet software (logging unit utility*).

* The logging unit utility can be downloaded for free from Mitsubishi Electric FA site.

Energy Measuring Unit Eco Monitor Plus



■ EcoMonitorLight

Energy measuring unit with integrated display for easily realizing the visualization of energy

A two-model line-up: a Three phase 3-wire system designed for users wanting simple power measurements at low cost; and a Three phase 4-wire system designed for users looking for basic power measurements plus something extra (harmonic measurements, alarm monitoring, etc.).

Simple Measurements

The built-in LCD enables easy setting, measurement and display of power used for energy management.

MODBUS® RTU (RS-485) Communication as Standard Equipment

Meters come with MODBUS® RTU communication as standard equipment, allowing the device to be used as a PLC system, other high-order system, display device (GOT), etc.

Logging/Communication Units for Expanded Measurement Applications

The product line-up also includes logging units/communication units (CC-Link communication unit) that can be incorporated as add-on options, enabling installations that best match to the customer's usage environment.

■ Logging unit: Data measured by the main unit (current, voltage, power, etc.) can be output to an SD memory card in CSV file format, realizing simple data management.

Highly Accurate Measurements and Support Functions

Customer activities are supported through functions such as 250μs high-precision (short-cycle load) measurement, operating time measurement, wiring error detection and test output.

Energy Measuring Unit Eco Monitor Light



Safety Precautions

To ensure safety, read the following items carefully before use and always comply with procedures during use. Special attention should be given to items enclosed in a box and marked "Caution." Additionally, please carefully read the operations manual supplied with the product before use, and ensure that the manual read by the end user as well.

1 Usage Environment and Conditions

Do not use these products under any of the following conditions. Doing so may cause erroneous operation and/or reduced service life.

- Ambient temperature is outside the range of -5~55°C
- Daily average temperature over 35°C
- Relative humidity over 85% or presence of condensation
- Presence of excessive dust, corrosive gas, salt or oil/smoke
- Product is subject to excessive vibration or shock
- Product is in direct contact with rain, water drops or sunlight
- Altitude is above 2,000m
- Excessive external noise
- Pollution level is 2 or higher
- Transient overvoltage is 4,000V or higher
- Presence of metal fragments or conducting substances

2 Installation

Please note the following items regarding installation. To ensure safety, installation is to be performed by a qualified technical electrician.

- Affix the main unit to the panel before use
- The LCD display contrast changes depending on the angle from which it is viewed. Install it in a position that ensures a suitable angle of view.
- Tighten screws using a torque of approx. 0.3~0.5N·m
- To prevent damage to the LCD, take care not to subject the LCD/front of the main unit to shock/impact.

Auxiliary power supply and instrument ratings

Auxiliary power supply		100~240VAC (±15%) 50-60Hz 100~240VDC (-30%, +15%)
Instrument ratings	Voltage	Three phase, 4-wire: Max. 277/480VAC
		Three phase, 3-wire: Delta connection: Max. 220VAC, Star connection: Max. 440VAC
		Single phase, 3-wire: Max. 220/440VAC
		Single phase, 2-wire: Delta connection: Max. 220VAC, Star connection: Max. 440VAC
	Current	5A/1A
	Frequency	50-60Hz (dual use)

3 Connections

See pages 26~28 of this catalog for information regarding connections.

 CAUTION	<ul style="list-style-type: none"> • To ensure safety, connections are to be performed by an electrical engineer qualified in wiring. • Check connection diagrams carefully before performing connections. Incorrect connections may result in VT burnout caused by a VT secondary-side short circuit or high voltage on the CT secondary side, which may lead to device malfunction, fire or electrical shock. • Do not work with live wires; there is a risk of electric shock and exposure to high voltage due to short-circuiting or CT secondary side opening, which may lead to malfunction, fire or electrical shock. • Use electrical wire sizes compatible with the rated current. Use of unsuitable sizes may cause heat generation, which may lead to a fire. • After performing connections, check that no connections have been missed. Missed connections may result in erroneous operation or high voltage on the CT secondary side, which may lead to a fire or electrical shock. • At the time of wiring, an electric wire can be broken by pulling with strong power. (The load of pulling is less than 3-9 N)
--	--

4 Preparations Before Use

- Before use, perform settings such as the VT primary voltage, CT primary current, power scale and demand time limit in accordance with the operations manual supplied with the product; setting errors may cause incorrect measurement/operation.

5 Usage Procedures

- Use the products within the rated range. Using the products outside the rated range may cause erroneous operation or product malfunction.
- Do not use the products for special applications such as nuclear power, aerospace or medical devices/systems.

 CAUTION	<ul style="list-style-type: none"> • Do not make any modifications to the products. Using products after modification may cause a malfunction, electrical shock or fire.
--	---



6 Repairing at Time of Malfunction/Error

- If a product listed in this catalog malfunctions, read the troubleshooting section of the operations manual (detailed version) and confirm the symptoms. If the problem is not listed, please contact a Mitsubishi Electric representative.

7 Maintenance/Inspections

- Wipe away any dust/dirt on the surface of the product with a soft cloth.
- Do not leave chemical cloths, etc. in contact with the product for long periods, and avoid the use of benzene, thinner, etc. when wiping the product surface. Doing so may cause deformation or cause the coating to peel away.
- To ensure correct use for the full service life of the product, please perform the following inspections:
 - ① Check for damage to the product
 - ② Check for display malfunctions (e.g., does not respond to input)
 - ③ Check for loose installation or terminal block wire connections (check regularly once every six months/year) always making sure that power has been turned off beforehand)
 - ④ Check for unusual smell, noise or rise in temperature.

8 Storage

Do not store the product for long periods of time under any of the following conditions. Doing so may lead to a malfunction or reduced service life.

- Ambient temperature outside the range of -25~+75°C
- Daily average temperature of more than 35°C
- Relative humidity exceeding 85% or condensation present
- Excessive dust, corrosive gas, salt or oil/smoke present
- Product is subject to excessive vibration or shock
- Product is in direct contact with rain, water drops or sunlight

9 Disposal

- These products do not use nickel-cadmium batteries. Dispose of them as industrial waste.
- The optional module ME-0000BU-SS96 contains a lithium battery. Dispose of the battery in accordance with the municipal regulations.
- In EU member states, there is a separate collection system for used batteries. Dispose of the batteries properly at the local collection/recycling center. The following symbol is printed on the package of ME-0000BU-SS96.



This symbol is applicable only in EU member states. The symbol is designated in Article 20 "Information for end-users" and Annex II of the new European Directive on batteries (2006/66/EC).

The above symbol indicates that the batteries must be disposed of after separation from general waste.

CAUTION

- The optional module ME-0000BU-SS96 contains a lithium battery. Therefore, if it is thrown into the fire, it may generate heat, rupture or ignite. Dispose of the lithium battery in accordance with the municipal regulations.

10 Warranty Period

The warranty period for the products in this catalog expires one year from the date of purchase or one year and six months after the date of manufacture; whichever is earliest. Even during the warranty period, the warranty shall not apply to malfunctions attributable to intentional negligence or erroneous use by the customer, and the fee for any repair required as the result of such negligence shall be the liability of the customer.

Mitsubishi Electric shall not be liable for: Damage that cannot be attributed to Mitsubishi Electric; lost opportunity or earnings resulting from failure of a Mitsubishi Electric product; damage, secondary damage or compensation for an accident resulting from special circumstances regardless of whether or not the circumstances were foreseeable; or damage to products or other services for products not manufactured by Mitsubishi Electric.

11 Product Exchange Cycle

Although it depends on usage conditions, as a guide, it is recommended that the products listed in this catalog be renewed after 10 years.

ELECTRONIC MULTI-MEASURING INSTRUMENT

Service Network

Country/Region	Corporation Name	Address	Telephone
Australia	Mitsubishi Electric Australia Pty. Ltd.	348 Victoria Road, Rydalmere, N.S.W. 2116, Australia	+61-2-9684-7777
Bangladesh	PROGRESSIVE TRADING CORPORATION ELECTRO MECH AUTOMATION & ENGINEERING LTD.	HAGUE TOWER, 2ND FLOOR, 610/11 JUBILEE ROAD, CHITTAGONG, BANGLADESH SHATABDI CENTER, 12TH FLOOR, SUITES - 12-B, 292, INNER CIRCULAR ROAD, FAKIRA POOL, MOTIJHEEL, DHAKA-1000, BANGLADESH	+880-31-624307 +88-02-7192826
Belarus	Tehnikon	Oktyabrskaya 19, Of. 705, BY-220030 Minsk, Belarus	+375 (0)177 210 46 26
Belgium	Koning & Hartman B.V.	Woluwealaan 31, BE-1800 Vilvoorde, Belgium	+32 (0)2 2570240
Brazil	Mitsubishi Electric Do Brasil Comercio E Servicos Ltda.	Av. Adelinio Cardana, 293 -21 and - Bethaville, 06401-147, Barueri/SP - Brasil	+55-11-4688-3000
Cambodia	DHINIMEX CO., LTD	#245, St. Top Phnom, Phnom Penh, Cambodia	+855-23-997-725
Chile	Rhona S.A.	Via. Agua Santa 4211 Casilla 30-D (P.O. Box) Vina del Mar, Chile	+56-52-2-320-600
	Mitsubishi Electric Automation (China) Ltd.	Mitsubishi Electric Automation Building, No.1388 Hongjiao Road, Shanghai, 200036	+86-21-3232-3030
	Mitsubishi Electric Automation (China) Ltd. North China Branch	9/F, Office Tower1 Henderson Centre 18 Jiaquomennei Dajie DongCheng district Beijing 100005	+86-10-6518-8830
	Mitsubishi Electric Automation (China) Ltd. NorthEast China Branch	Room2302, President Building Tower C, No.69 Heping North Avenue, Heping District, Shenyang 110003	+86-24-2259-8830
	Mitsubishi Electric Automation (China) Ltd. South China Branch	Room 2512-2516, Great China International Exchange Square, Jintian Rd.S., Futian District, Shenzhen, 518034	+86-755-2399-8272
	Mitsubishi Electric Automation (China) Ltd. South China Branch	Room 1609, North Tower, The Hub Center, No.1068, Xing Gang East Road, Haizhu District, Guangzhou, China 510335	+86-20-8923-6730
	Mitsubishi Electric Automation (China) Ltd. SouthWest China Branch	1501, 1502, 1503, 15F, Guang-hua Centre, Block C, NO.98 Guang Hua North 3th Road Chengdu, 610000	+86-28-8446-8030
	Mitsubishi Electric Automation (Hong Kong) Ltd.	20/F, Cityplaza One, 1111 King's Road, Taikoo shing, Hong Kong	+852-2510-0555
Colombia	Proelectrico Representaciones S.A.	Carretera 42 # 75-967 Bod 109 Itagu Colombia	+57-4-4441284
Czech Republic	AUTOCONT CONTROL SYSTEMS S.R.O	Technologicka 374/6, CZ-708 00 Ostrava - Pustkovice	+420 595 691 150
Denmark	BEJLER ELECTRONICS A/S	LYKKEGARDSVEJ 17, DK-4000 ROSKILDE	+45 (0)45 75 76 66
Egypt	CAIRO Electrical Group	9, Rostum St. Garden City P.O. Box 165-11516 Maglis El-Shaab, Cairo - Egypt	+20-2-27961337
France	Mitsubishi Electric Europe B.V.	25, Boulevard des Bouvets, F-92741 Nanterre Cedex	+33 (0) 1 56 68 55 68
Germany	Mitsubishi Electric-Platz 1, 40882 Ratingen, Germany		+49 (2102) 4860
Greece	KALAMARAKIS - SAPOUNAS S.A.	IONIAS & NEROMILOU STR., CHAMOMILOS ACHARNES, ATHENS, 13678 Greece	+30-2102 406000
	UTECO	5, MAVROGENOUS STR., 18542 PIRAEUS, Greece	+30-211-1208-900
Hungary	Meltrade Ltd.	Ferő utca 14, HU-1107 Budapest, Hungary	+36 (0)1-431-9726
India	Mitsubishi Electric India Private Limited	2nd Floor, Tower A&B, Cyber Greens, DLF Cyber City, DLF Phase-III, Gurgaon - 122 022 Haryana, India	+91-124-4630300
Indonesia	PT.Mitsubishi Electric Indonesia	Gedung Jaya 8th floor, J.L.MH. Thamrin No.12 Jakarta Pusat 10340, Indonesia	+62-21-3192-6461
	P. T. Sahabat Indonesia	Carera 42 # 75-967 Bod 109 Itagu Colombia	+62-(0)21-6610651-9
Ireland	Mitsubishi Electric Europe B.V.	Westgate Business Park, Ballymount, IRL-Dublin 24, Ireland	+353 (0)1-4198800
Israel	Gino Industries Ltd.	29, Ophir Street IL-32235 Haifa, Israel	+972 (0)4-867-9656
Italy	Mitsubishi Electric Europe B.V.	Viale Colleoni 7, I-20041 Agrate Brianza (MI), Italy	+39 039-60531
Kazakhstan	Kazpromavtomatika	ul. Zhambyla 28, KAZ - 100017 Karaganda	+7-712-5101000
Korea	Mitsubishi Electric Automation Korea Co., Ltd	9F Gangseo Hangang xi-tower, 401 Yangcheon-ro, Gangseo-gu, Seoul 07528 Korea	+82-2-3660-9572
Laos	AROUNKIT COOPERATION IMPORT- EXPORT SOLE CO.,LTD	SAPHANMO VILLAGE, SAYSETHA DISTRICT, VIENTIANE CAPITAL, LAOS	+856-20-415899
Lebanon	Comptoir d'Electricite Generale-Liban	Cebaco Center - Block A Autostrade Dora, P.O. Box 11-2597 Beirut - Lebanon	+961-1-240445
Lithuania	Rilas UAB	Tinklini 25A, LT-5300 Panevezys, Lithuania	+370 (0)45-582-728
Malaysia	Mitric Sdn Bhd	No. 5, Jalan Pemberita U1/49, Temasya Industrial Park, Glenmarie 40150 Shah Alam, Selangor, Malaysia	+603-5569-3748
Malta	ALFTRADE LTD	99 PAOLA HILL, PAOLA PLA 1702, Malta	+356 (0)21-697-816
Marocco	SCHIELE MAROC	KM 7 2 NOUVELLE ROUTE DE RABAT AIN SEBAA, 20600 Casablanca, Marocco	+212 661 45 15 96
Mexico	Mitsubishi Electric Automation, Inc.	Mariano Escobedo 69, Col. Zona Industrial, Tlalpanamitla, MEX - 54030 - MX	+52-3667-7500
Myanmar	Peace Myanmar Electric Co.,Ltd.	NO137/139 Bolahaung Pagoda Road, Bolahaung Town Ship 11161, Yangon, Myanmar	+95-(0)1-202589
Nepal	Wait&Volt House	KHA 2-65, Volt House Dillibazar Post Box-2108, Kathmandu, Nepal	+977-1-4411330
Netherlands	Imtech Marine & Offshore B.V.	Suisjesdijk 155, NL-3087 AG Rotterdam, Netherlands	+31 (0)10-487-19 11
North America	Mitsubishi Electric Automation, Inc.	500 Corporate Woods Parkway, Vernon Hills, IL 60061 USA	+847-478-2100
Norway	Scanelac AS	Leivikassen 43B, NO-5179 Godvik, Norway	+47 (0)55-506000
Middle East Arab Countries & Cyprus	Comptoir d'Electricite Generale-International-S.A.L.	Cebaco Center - Block A Autostrade Dora P.O. Box 11-1314 Beirut - Lebanon	+961-1-240430
	Prince Electric Co.	2-P QUILBERG II, LAHORE- 54600, PAKISTAN	+92-42-575232, 5753373
Pakistan	AL-KAMAL GROUP	OFFICE NO 7&8, 1ST FLOOR, BARKAT ALI KHAN CENTER, 101, CIRCULAR ROAD, LAHORE, PAKISTAN	+92-42-37631632
Philippines	Edison Electric Integrated, Inc.	24th Fl. Galleria Corporate Center, Edsa Cr. Ortigas Ave., Quezon City Metro Manila, Philippines	+63-(0)2-634-8691
	Mitsubishi Electric Europe B.V. Polish Branch	Krakowska 50, 32-083 Balice, Poland	+48 (0) 12 630 47 00
Poland	Mitsubishi Electric Europe B.V. Polish Branch	bid. Traian 23/1, MD-2060 Kishinev, Moldova	+373 (0)22-66-4242
Republic of Moldova	Intehsis SRL	RO-060841 Bucuresti, Sector 6 Aleea Lacul Morii Nr. 3	+40-(0)21-430-40-06
Romania	Sirus Trading & Services SRL	52, bid. 3 Kosmodamianskaya Nab. 115054, Moscow, Russia	+7 495 721-2070
Russia	Mitsubishi Electric Europe B.V. Moscow Branch	Al-Shuwayer St. Side way of Salahuddin Al-Ayoubi St. P.O. Box 15955 Riyadh 11454 - Saudi Arabia	+966-1-4770149
Saudi Arabia	Center of Electrical Goods	307 Alexandria Road, Mitsubishi Electric Building, Singapore 159943	+65-6473-2308
Singapore	Mitsubishi Electric Asia Pte. Ltd.	PROCENT, Presov	+421 (0)51 - 7580 611
Slovakia	PROCENT, Presov	Kupelna 1/ SK - 08001 Presov, Slovakia	+ 421 (0)32 743 04 72
Slovenia	SINAP	Jana Derku 1671, SK - 91101 Trenčin, Slovakia	+386 (0)1-513-8116
Slovenia	Inea RBT d.o.o.	Stegne 11, SI-1000 Ljubljana, Slovenia	+27-(0)11-9282000
South Africa	CBI-electric: low voltage	Private Bag 2016, ZA-1600 Isando Gauteng, South Africa	+34 (0)93-565-3131
Spain	Mitsubishi Electric Europe B.V. Spanish Branch	Carretera de Rubi 76-80, E-08190 Sant Cugat del Valles (Barcelona), Spain	+46 (0)300-690040
Sweden	Euro Energy Components AB	Järnvägsgatan 36, S-434 24 Kungälv, Sweden	+41-(0)52-6258425
Switzerland	TriElec AG	Muehlenstaltstrasse 136, CH-8201 Schaffhausen	+41-(0)52-6258425
Taiwan	Setsuyo Enterprise Co., Ltd	5th Fl., No. 105, Wu Kung 3rd, Wu-Ku Hsiang, Taipei, Taiwan, R.O.C.	+886-(0)2-2296-8889
Thailand	United Trading & Import Co., Ltd.	77/12 Bamrungmuang Road, Klom Mahanak Pomprab Bangkok Thailand	+66-223-4220-3
Tunisia	MOTRA Electric	3, Résidence Imen, Avenue des Martyrs Mourouj III, 2074 - El Mourouj III Ben Arous, Tunisia	+216-71 474 599
Turkey	GTS	Bayraktar Bulvarı Nutuk Sok. No.5, Posta Kutusu34384, TR-34775 Yukarı Dudulu-Uemraniye, Istanbul, Turkey	+90 (0)216 526 3990
United Kingdom	Mitsubishi Electric Europe B.V.	Travellers Lane, JK-Hatfield, Herts, AL10 8XB, United Kingdom	+44(0)1707-276100
Uruguay	Fierro Vignoli S.A.	Avda. Uruguay 1274 Montevideo Uruguay	+598-2-902-0808
Venezuela	Adesco S.A.	Calle 7 La Urbina Edificio Los Robles Locales C y D Planta Baja, Caracas - Venezuela	+58-212-241-9952
	Mitsubishi Electric Vietnam Co.,Ltd. Head Office	Unit01-04, 10th Floor, Vincom Center, 72 Le Thanh Ton Street, District 1, Ho Chi Minh City, Vietnam	+84-8-3910-5945
Vietnam	Mitsubishi Electric Vietnam Co.,Ltd. Hanoi Branch	6th Floor, Detech Tower, 8 Ton That Thuyet Street, My Dinh 2 Ward, Nam Tu Liem District, Hanoi City, Vietnam	+84-4-3937-8075

Safety Tips: Be sure to read the instruction manual fully before using this product.

Precautions Before Use

- Please consult with a Mitsubishi Electric representative when considering the application of products presented in this catalogue with machinery or systems designed for specialized use such as nuclear power, electrical power, aerospace/outer space, medical, or passenger transportation vehicles.
- Mitsubishi Electric Corporation shall not be liable, to the customer or equipment user, for:
 - 1) Any damage found not to be attributable to a Mitsubishi Electric product.
 - 2) The loss of opportunity or profits for the customer or user caused by any fault in a Mitsubishi Electric product.
 - 3) Damage, secondary damage or accident compensation resulting from special factors regardless of whether or not such factors could be predicted by Mitsubishi Electric.
 - 4) Damage to products of other companies and/or guarantees relating to other services.



for a greener tomorrow

Eco Changes is the Mitsubishi Electric Group's environmental statement, and expresses the Group's stance on environmental management. Through a wide range of businesses, we are helping contribute to the realization of a sustainable society.



MITSUBISHI ELECTRIC CORPORATION

HEAD OFFICE: TOKYO BUILDING, 2-7-3, MARUNOUCHI, CHIYODA-KU, TOKYO 100-8310, JAPAN